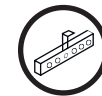

LONG
THROWVERSATILE SYSTEM
MAIN PA &
STAGE MONITORMULTIPLE PRESETS
AVAILABLE with external
Amate Audio amplifier & DSPHIGH RESISTANCE
POLYUREA PAINT®ACCESSORIES FOR
EASY INSTALLATIONS

A main PA and stage monitor 800W passive system with accurately designed components. The 60° x 50° constant directivity horn makes it ideal for long coverage.

KEY FEATURES

TRANSDUCERS TECHNOLOGY

Two-way full range passive speaker system composed by one direct radiating 3-inch voice coil, 15" loudspeaker and one 1,75-inch voice coil diameter, 1,4-inch exit, PM4 diaphragm compression driver loaded to a 60° x 50° dispersion horn.

POWER & CONTROL

800 W continuous power in musical program.

An accurate internal passive crossover achieves an optimum performance while including a protection on high frequency driver.

Connectors are placed on an inclined plane to effectively protect them against rain or moisture.

Double Speakon NL4MPR® (input & link).

Recommended presets available for DSP206, DSP608, LMS206.

DESIGN & ACCESSORIES

Ergonomic handles for an easy handling.

Trapezoidal shape for PA or stage monitor application

2mm speaker grille with black mesh, exclusively designed with an optimum perforation gradient and attractive appearance.

Multilayer birch plywood cabinet with Polyurea® coating, offering maximum reliability and strength for touring as well as for high demanding applications.

M8 rigging points for easy flying.

35mm diameter pole mount socket mounted on the bottom side, for a standard tripod.

Protective rubber profiles.

TECHNICAL FEATURES

Power (musical program)	800 W
Power (r.m.s)	400 W
Nominal Impedance	8 Ω
SPL(1W/1m)	99 dB
Maximum SPL (continuous/1m)	128 dB
Maximum SPL (peak/1m)	131 dB
Crossover frequency	1k5 Hz
Frequency Response (-10dB)	50 Hz – 18 kHz
Components	LF - MF 15" woofer (3" voice coil) HF 1,75" PM4 diaphragm compression driver
Directivity (HxV)	60° x 50°
Directivity factor (Q)	20
Directivity Index (DI)	13 dB
Weight	27.8 Kg
Finish	Multilayer birch plywood with high resistant black Polyurea® coating and protective rubber profiles
Dimensions (HxWxD)	733 x 435 x 473 mm
Grille	2 mm steel with black acoustic mesh
Rigging	M8 points
Connectors	1x Speakon NL4MPR input / 1x Speakon NL4MPR link

DISCOVER NÍTiD



UNIQUE DESIGN

Distinguishing details include the speaker grille, exclusively designed for an attractive appearance, maximum protection, and with **the best performance coefficient in the market, for improved sound quality.** The Polyurea® finish offers durable protection for the birch-ply cabinet. A wide range of accessories is provided for whatever your application is.



THE PERFECT BALANCE

NÍTiD series is the culmination of an intensive program of research, development and optimization, to achieve the greatest possible power and performance from the most compact sized cabinet. Every aspect of its form factor has resulted from examination and consideration of optimum acoustic response, ergonomics, construction and appearance.



TOP VIEW



BOTTOM VIEW



SIDE VIEW



FRONT VIEW



REAR VIEW

FREQUENCY RESPONSE 1W/1m

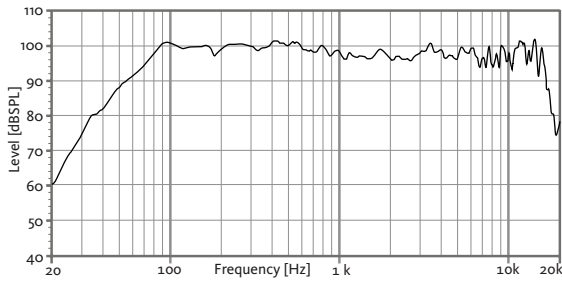

HORIZONTAL COVERAGE

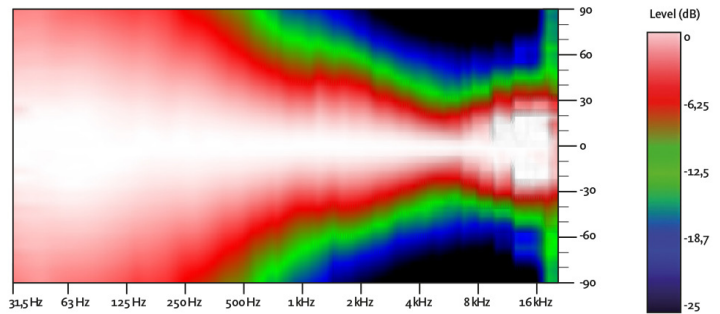

DIRECTIVITY INDEX (DI)

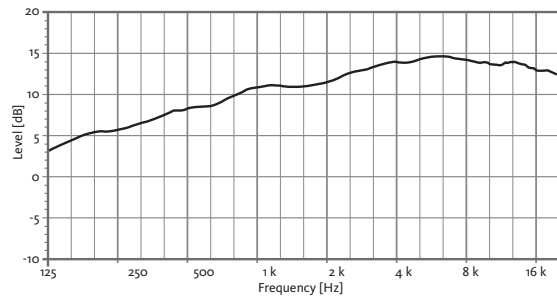

VERTICAL COVERAGE

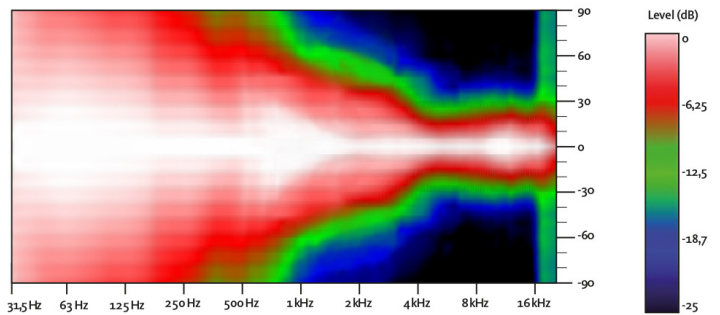

HORIZONTAL & VERTICAL BEAMWIDTH (-6dB point)

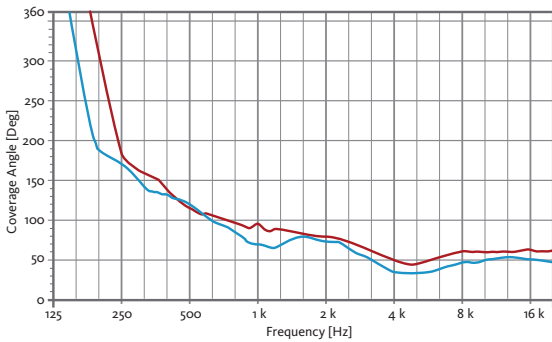

CAD DRAWING SCHEME

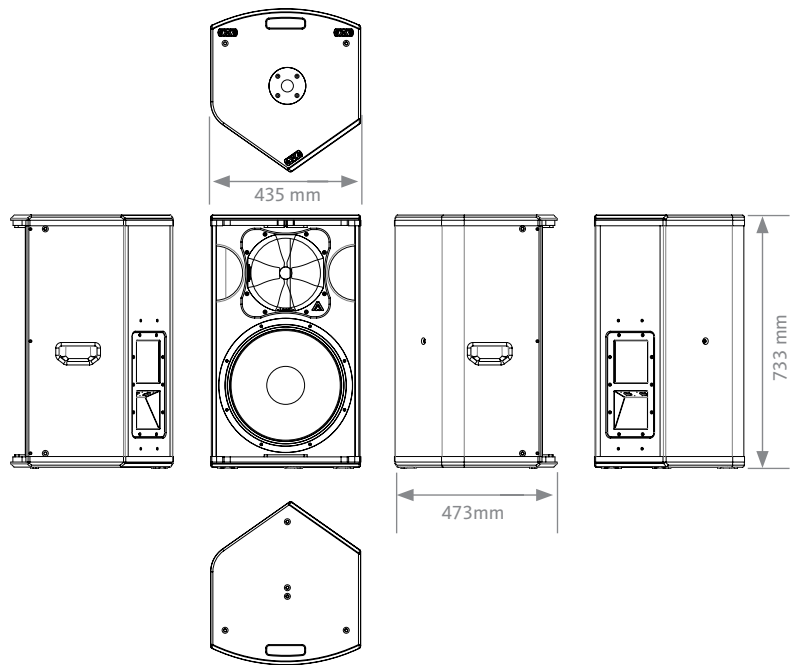

RECOMMENDED PRESETS with external Amate Audio DSP

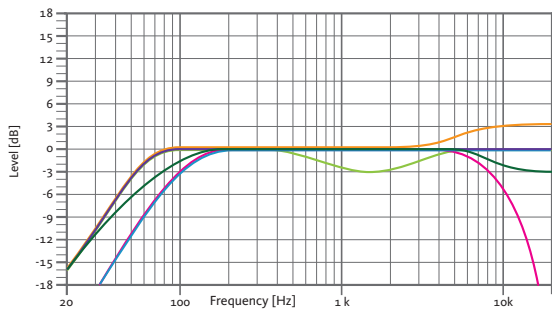

FLAT

Flat response

NEARFIELD

-3 dB mid frequencies (400 Hz – 4 kHz)

LONGTHROW

+3 dB high frequencies

SPEECH

HPF 100 Hz

LPF 8 kHz

MONITOR

Stage monitor use

XOVER

HPF 100 Hz

ACCESSORIES

FLIGHT CASE

FC-N15

for two units of N15PR



WALL MOUNT BRACKET

UB-L



TELESCOPIC DISTANCE ROD

SP-CRTL

ø: 35 mm
Length: 55 cm ~ 90 cm
Thread: M20



WALL-MOUNT BRACKET

SP-WHR



FLYING BAR

HR-L



FLYING BAR WITH HOOK

HR-L/GT



M8 RIGGING EYEBOLT

ACR-M8



SAFETY SLING

SC-15



HORIZONTAL WALL-MOUNT

UB-L + SC-15

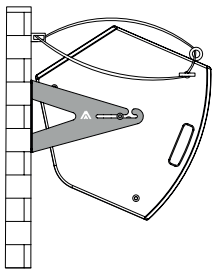

VERTICAL WALL-MOUNT

SP-WHR + SC-15

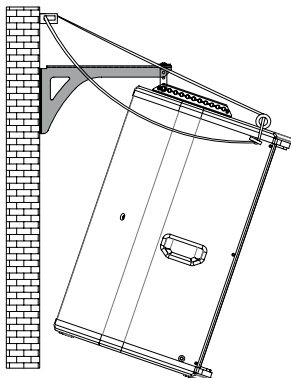

VERTICAL COLUMN-MOUNT

HR-L + SC-15

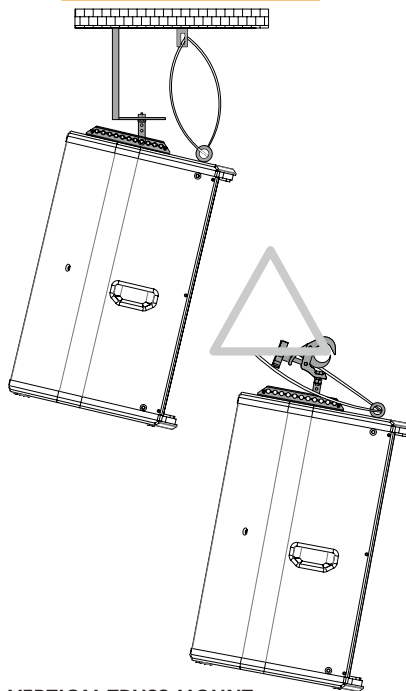

VERTICAL TRUSS-MOUNT

HR-L/GT + SC-15

THE BEST COMBINATION

The best experience of NITID passive systems is reached with Amate Audio's HD series amplifiers and DSP206/608 or LMS206 digital signal processors. Factory presets are available to set-up the system in a short time.



HD Series



LMS206



DSP Series

RECOMMENDED CONFIGURATION

FOR N15PR (2 units)

Connect each cabinet output of the amplifier LEFT/RIGHT to each cabinet using two independent wires.

FOR N15PR (4 units)

Connect the amplifier's output to the Speaker's input of the first cabinet. Then, make a bridge from the first cabinet to the second one. This configuration allows you to connect up to four cabinets to the same amplifier.

