



WITH CWK-D

Style and performance come together in the X208. Exclusive, customized waveguide projects sound with consistency at great distance, allowing you to handle nearly any application. Amate Audio technology in X208 delivers ease of use a unique sound quality in a compact size. Innovation that you can hear!

KEY FEATURES

TRANSDUCER TECHNOLOGY

Two-way line array active speaker system composed by two 2.5-inch voice coil, neodymium magnet, 8" loudspeakers and two 1.75-inch PEN diaphragm neodymium drivers coupled to a 110° x 11° exclusive high performance waveguide.

AMPLIFICATION

Each X208 system is constructed in multiples of four modules: one active unit X208A, which includes the amplification and the digital signal processor (DSP) and up to three passive units X208P, which are driven by the X208A.

3rd generation Class D built-in amplifier with a total power of 3000 W, controlled by a dedicated DSP.

90% efficiency amplifier SMPS (switching mode power supply), allowing maximum power delivery with minimum consumption in an extremely low-weight and reduced size.

Rear connections and control panel with LCD screen to display the different settings, presets and adjustments done by the user.

A capacitive keyboard guarantees the reliability of the system even under humidity and extreme weather conditions.

Exclusive and unique Overvoltage Protection which continuously monitors line voltage and instantly disconnects the system if the line voltage exceeds the maximum permissible level.

DSP & CONTROL

Internal DSP with all necessary signal processing (crossovers, EQs, delay, limiters, gain control, mute) as well as several useful presets to adjust X208 to different requirements.

Ethernet connection and full wireless control. The system can be monitored from any spot in the room.

DSPStudio® control software capable of adjusting and setting-up even the finest details and monitoring key parameters of the amplifier: input and output levels, clip limiter activation, amplifier temperature and network connection status.

DESIGN & ACCESSORIES

Several accessories allow easy flying. Inter-cabinet connection is set via front-mounted fix linking plates and angles are set via rear-mounted adjustable plates.

Ergonomic handles for an easy and comfortable transport.

Baltic birch plywood cabinet with Polyurea® coating, offering maximum reliability and strength for touring as well as for high demanding applications.

X208

2x 8" LINE ARRAY SYSTEM

Xcellence



DSP STUDIO CONTROL APP FOR IPAD & WINDOWS



WITH CWK-D



EXCLUSIVE HIGH PERFORMANCE WAVEGUIDE



LIGHT NEODYMIUM COMPONENTS



> 250 V OVERVOLTAGE PROTECTION



MULTIPLE PRESETS AVAILABLE



HIGH RESISTANT POLYUREA® PAINT



ACCESSORIES FOR EASY INSTALLATIONS

TECHNICAL FEATURES

Amplifier (program power)	2400 W (LF) + 600 W (HF) – Class D Bi-amplified
Input sensitivity	8 dBu – 1.94 V
Input Impedance	20 kΩ Balanced
Mains	Universal Switch Mode Power Supply 85-265 V / 45-65 Hz
Average current draw	3.8 A (Heavy duty musical program)
SPL (1 m)	130 dB continuous, 133 dB peak
Built-in DSP	48 bit
AD/DA converters	24 bit – 96 kHz
Presets	4FLAT_FR / 4FLAT_SW / 4ARC_FR / 4ARC_SW / 4ARC+_FR / 4ARC+_SW / 8FLAT_FR / 8FLAT_SW / 8ARC_FR / 8ARC_SW / 8ARC+_FR / 8ARC+_SW / 2ARC_FR / 2ARC_SW / 2ARC+_FR / 2ARC+_SW + 23 configurable user memories
Crossover frequency	1k1Hz
Frequency response (-10 dB)	78 Hz – 18 kHz
Components	LF 2x 8" neodymium woofers (2.5" voice coil) HF 2x 1.75" PEN diaphragm neodymium drivers
Directivity (HxV)	110° x 11°
Directivity factor (Q)	31
Directivity index (DI)	15 dB
Weight	25 kg (X208A) / 22 kg (X208P)
Dimensions (HxWxD)	279 x 684 x 522 mm (no pins included)
Finish	Multilayer baltic birch plywood with high resistant black Polyurea® coating
Grille	1.5 mm steel with grey micro-foam cloth
Rigging	Stainless-steel integrated rigging bars
Connectors	1x XLR input / 1x XLR link / 1x AC PowerCon input / 1x AC PowerCon link / 1x EtherCon RJ45 input / 1x EtherCon RJ45 link



SIDE VIEW



FRONTAL VIEW WITHOUT GRILLE

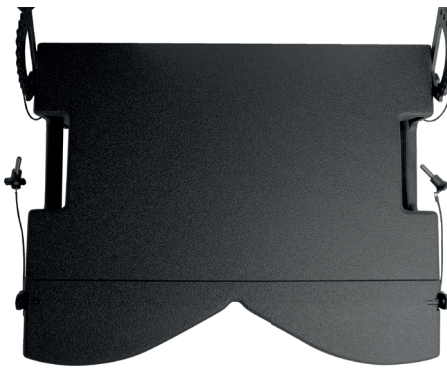

TOP VIEW



REAR VIEW

X208 SET (1x X208A + 3x X208P)

X208

2x 8" LINE ARRAY SYSTEM



FREQUENCY RESPONSE 1w/1m (4FLAT_FR PRESET) ONE CABINET

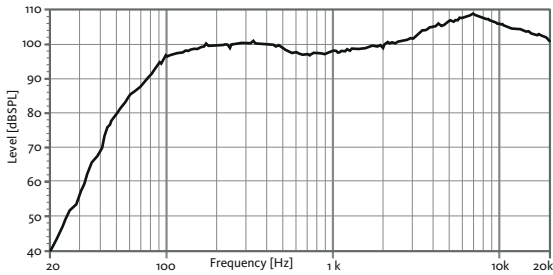

HORIZONTAL COVERAGE

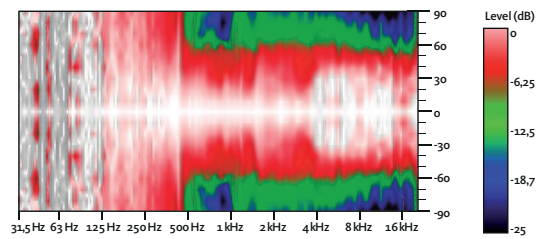

VERTICAL COVERAGE

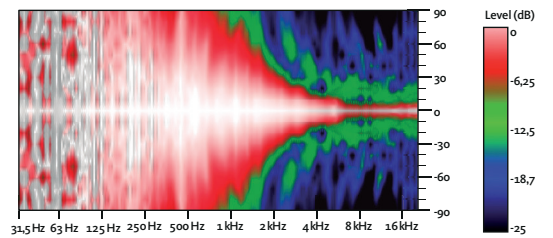

HORIZONTAL & VERTICAL BEAMWIDTH (-6dB point)

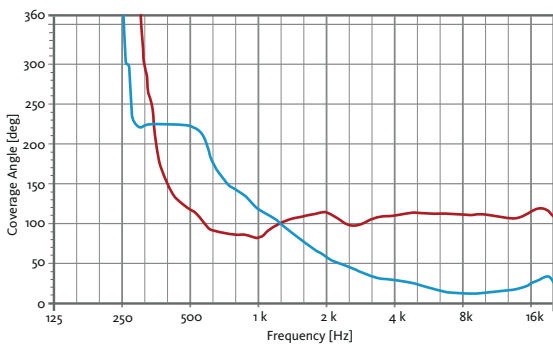

DIRECTIVITY INDEX (DI)

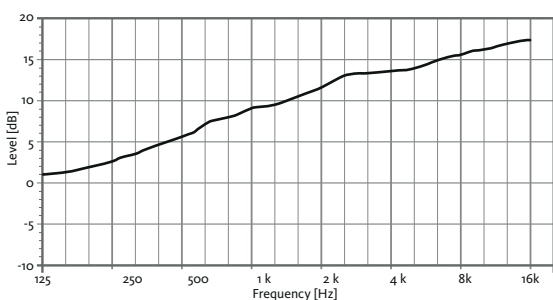

X208 SET

1x X208A (active)
3x X208P (passive)



X208A ACTIVE MODEL



X208P PASSIVE MODEL

CONNECTION PANEL

CAD DRAWING SCHEME

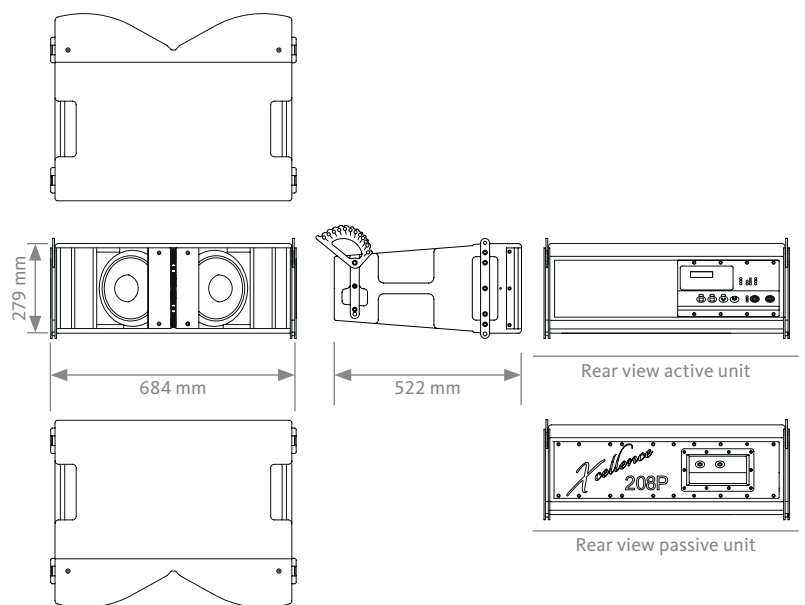

X208

2x 8" LINE ARRAY SYSTEM

Xcellence



ACCESSORIES

FLIGHT CASE FC-X208
For four units of X208



TOURING BUMPER TA-X208R
For flying X208



FRAME ADAPTOR FA-X208/215
For X208 underneath X215W



FRAME ADAPTOR FA-X208/210
For X208 underneath X210



STACKING FRAME FR-208R
For X208 over X18T or X218WF

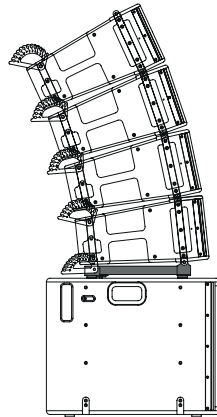

WIRELESS COMMUNICATION KIT CWK-D
Bespoke control protocol that supports Wi-Fi connectivity through CWK-D



DSP STUDIO CONTROL SOFTWARE



"Instant access to outstanding sound"

1

Configure your wifi network

2

Detect loudspeakers

3

Setup audio settings

4

Enjoy the best sound

The application utilises a bespoke control protocol that supports Wi-Fi connectivity (control over IP).

It allows to address the ethernet-enabled amp and DSP modules in the Xcellence series cabinets, affording the user visual feedback on amplifier status and the ability to edit processor values from any spot in the venue.

You can edit parameters such as crossover frequency, gain (per way and separately mutable), limiter, polarity, delay, five custom parametric EQs or an array of filter shapes, can all be adjusted in fine detail, with several elements controllable at the same time using grouping functions.

The app also provides comprehensive information about input and output levels, heat-sink temperature, clip and protection indicators.



iPad VERSION



PC VERSION

Download it from our website: www.amateaudio.com