



LIGHT  
NEODYMIUM  
COMPONENTS



ASYMMETRICAL  
DISPERSION  
HORN



VERSATILE FoH PA &  
STAGE MONITOR



REAR PANEL  
TOUCHSCREEN GUI  
OPERATION



INTEGRATED POWER &  
CONTROL WITH MULTIPLE  
PRESETS



HIGH RESISTANCE  
POLYUREA® FINISH &  
PROTECTIVE RUBBER PROFILES



EASY RIGGING &  
INSTALLATION ACCESSORIES

Compact dual-purpose main PA and stage monitor system. Superb vocal articulation, smooth bass response and crystal clear high frequencies distinguish the S12's uniquely balanced, powerful sonic performance in this product class.

## KEY FEATURES

### TRANSDUCER TECHNOLOGY

Two-way, full range active loudspeaker system comprising a direct radiating 3-inch voice coil, neodymium magnet 12" loudspeaker and one 1.5-inch voice coil diameter, polymer diaphragm neodymium magnet ring HF driver loaded to an asymmetrical rotational horn (50° to 100° x 55° dispersion).

### AMPLIFICATION

Onboard 1000 W 3rd generation Class D bi-amplification.

Universal switch mode power supply (SMPS) with Power Factor Correction (PFC), allowing constant power delivery from 85 to 265 VAC input and high efficiency (>90%), with extremely compact lightweight form factor.

Automatic EcoMode low power consumption mode when no signal input present.

Connectors mounted on an inclined, recessed moulded connector plate for improved security and environmental protection.

Double PowerCon® connectors (input & link).

### ADVANCED DSP SYSTEM CONTROL

Onboard 64-bit precision DSP loudspeaker system control manages amplifier gain and cross-over settings, peak and thermal limiters and mutes. Includes adjustable 294 ms / 100 m delay line for extensive alignment delay and 5-band fully configurable parametric EQ.

High-order FIR filtering ensures fully phase coherent PEQ adjustment and absolute phase alignment of common cabinet couplings.

Extensively R&D'd factory presets provide instantaneous system configuration for common applications, including point-source PA, floor monitor, speech, and subwoofer coupling.

ALC (Adaptive Loudness Compensation) improves the listening experience when the system is used at low volume levels.

Operation and monitoring of system parameters, presets and user-adjustments is via Amate Audio's unique rear-panel 3.5" TFT colour touchscreen GUI. The front-panel Nítid backlit logo can be switched on or off, or set to indicate system limiting.

### DESIGN & ACCESSORIES

Recessed ergonomic carry handles for easy handling.

Asymmetric trapezoidal form for PA or floor monitor application.

Exclusive 1.5mm black mesh speaker grille with optimum perforation gradient and attractive appearance.

Multilayer birch plywood cabinet with Polyurea® coating and protective rubber profiles, providing maximum robustness and strength for touring, events production, venue installation and other highly demanding applications.

M8 rigging points for easy flying.

35mm diameter pole mount socket mounted on the bottom side, for a standard tripod.

## TECHNICAL FEATURES

Amplifier (program)	800 W (LF) + 200 W (HF) Class D Bi-amplified	
Input sensitivity	8 dBu – 1.94 V	
Input Impedance	50 kΩ Balanced	
Mains	Universal Switch Mode Power Supply 85-265 V/ 45-65 Hz	
Average current draw	1.7 A (Heavy duty musical program)	
SPL(1m)	128 dB musical program, 131 dB peak	
Built-in DSP	64-bit processing unit. Includes factory presets	
AD/DA converters	24 bit – 48 kHz	
Standby mode consumption	3.7 W @230VAC	
Adjustable delay line	294 ms / 100 m	
Crossover frequency	1k9 Hz	
Frequency response (-10dB)	52 Hz – 19 kHz	
Components	LF - MF	12" neodymium woofer (3" voice coil)
	HF	1.5" polymer diaphragm neodymium magnet ring driver
Directivity (-6dB)	50° to 100° (H) x 55° (V)	
Directivity factor (Q)	12.6	
Directivity Index (DI)	11 dB	
Weight	19.9 Kg	
Dimensions (HxWxD)	623 x 363 x 398 mm	
Finish	Multilayer baltic birch plywood with high resistant black Polyurea® coating and protective rubber profiles	
Grille	1.5mm powder coated steel with black acoustic mesh	
Rigging	M8 points	
Connectors	1x XLR input / 1x XLR link / 1x AC PowerCon® input / 1x AC PowerCon® link	

## TOUCHSCREEN CONTROL



Amate Audio's latest generation DSP System management is integrated with 3rd generation Class D amplification. Colour touchscreen operation and monitoring of DSP System includes access to powerful presets - engineered by Amate Audio R&D team – that instantly configure your Nítid loudspeaker for the majority of common application environments within seconds, prior to rigging or installation.



TOP VIEW



BOTTOM VIEW



SIDE VIEW



FRONT VIEW



REAR VIEW

### FREQUENCY RESPONSE 1w/1m (FLAT PRESET)

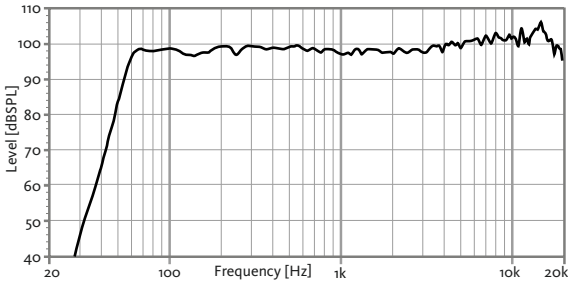

### DIRECTIVITY INDEX (DI)

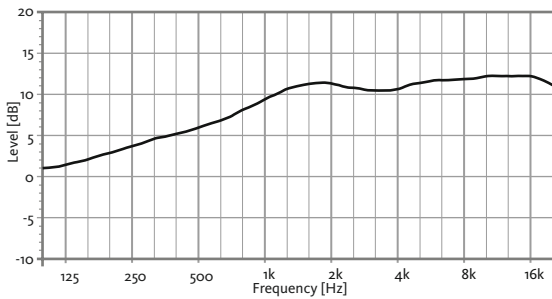

### HORIZONTAL & VERTICAL BEAMWIDTH (-6dB point)

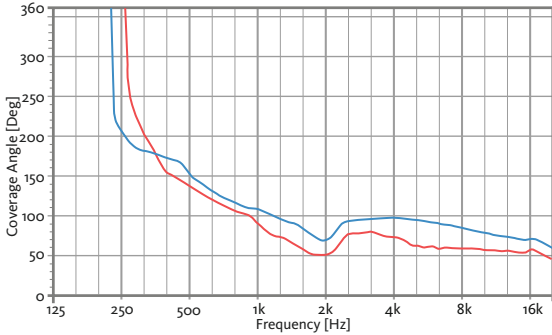

HORIZONTAL VERTICAL

### BUILT-IN PRESETS

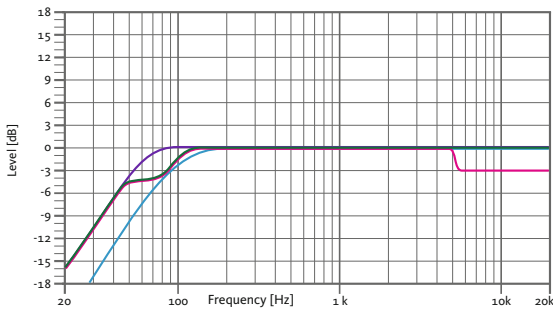

**FLAT**  
Flat response  
**SPEECH**  
Vocal use

**HPF90**  
HPF 90 Hz  
**MONITOR**  
Stage monitor use

### HORIZONTAL COVERAGE

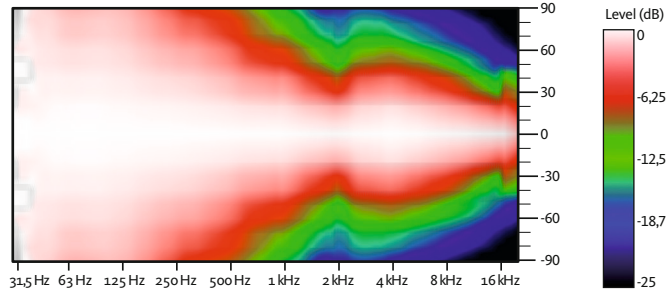

### VERTICAL COVERAGE

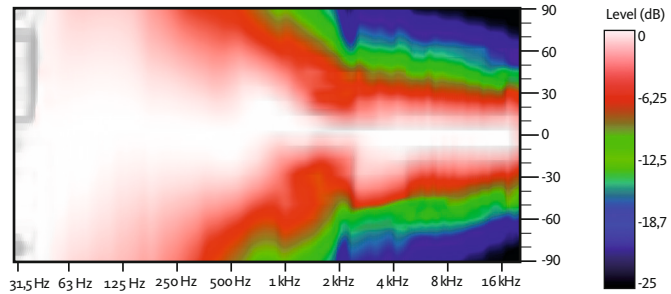

### CAD DRAWING SCHEME

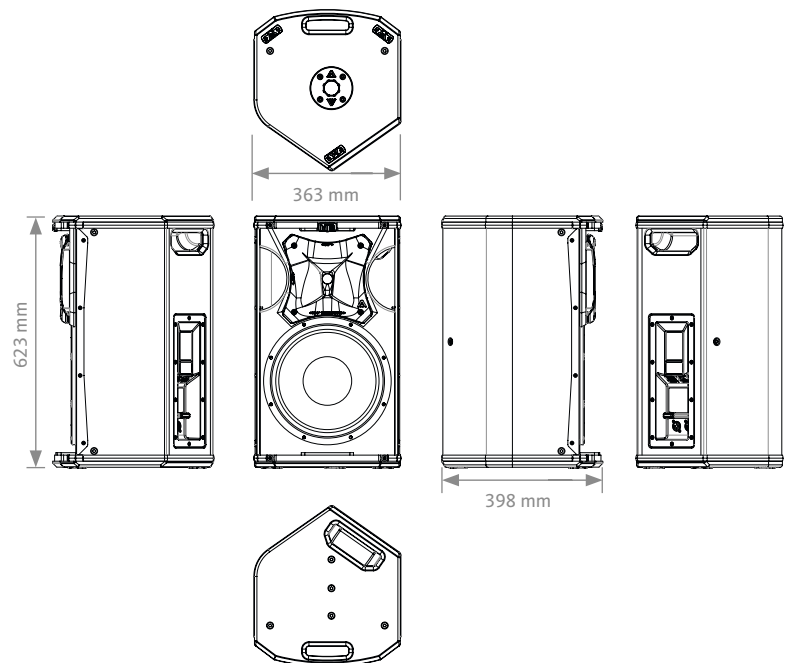



**ACCESSORIES**

**WALL MOUNT BRACKET**

UB-L



**WALL-MOUNT BRACKET**

SP-WHR



**FLYING BAR**

RB-L



**FLYING BAR WITH HOOK**

RB-L/GT



**SAFETY SLING**

SC-15



**M8 RIGGING EYEBOLT**

ACR-M8



**FLIGHT CASE**

FC-S12

for two units of S12



**TELESCOPIC DISTANCE ROD**

SP-CRTL

ø: 35 mm  
Length:  
55 cm ~ 90 cm  
Thread: M20



**PROTECTION COVER**

NC-S12



**DISCOVER NÍTID**

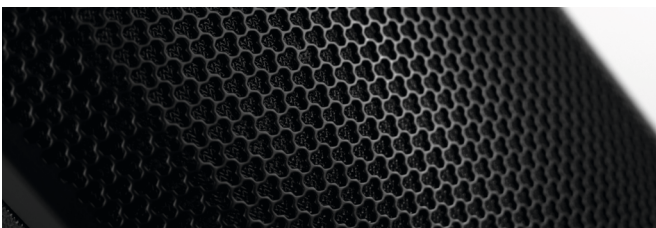

**UNIQUE DESIGN**

New S-series models build on the success, innovation and best-in-class performance of the original Nítid designs with improved features including a recessed moulded connector plate, more highly stylised form factor and improved robustness of the world's most acoustically transparent pro-audio speaker grille.



**THE PERFECT BALANCE**

An ongoing programme of research and development ensures that Nítid series loudspeakers continue to achieve the highest levels of output and performance from the most compact sized designs, in an unrivalled synthesis of engineering and aesthetic form.

**ASYMMETRICAL DISPERSION HORN**

It allows to optimize the coverage depending on its position.

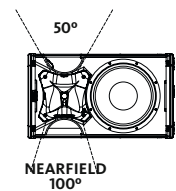
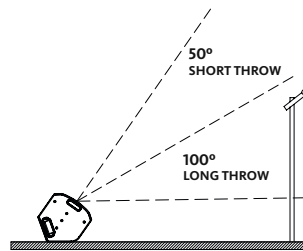
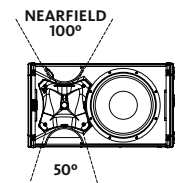
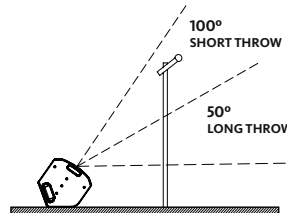
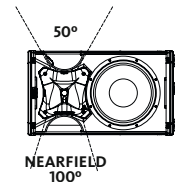
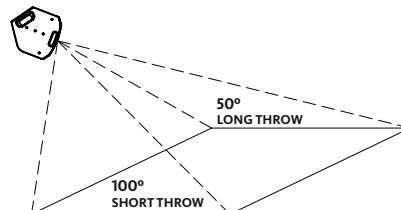
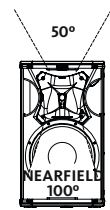
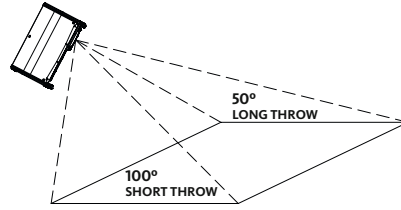

**VERTICAL COLUMN-MOUNT**  
RB-L + SC-15

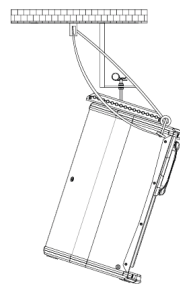

**VERTICAL TRUSS-MOUNT**  
RB-L/GT + SC-15



**VERTICAL WALL-MOUNT**  
SP-WHR + SC-15

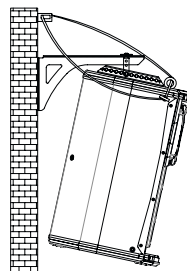

**HORIZONTAL WALL-MOUNT**  
UB-L + SC-15

