

User's manual

Subwoofer arrays

Recommended configurations
May 2020



*Great sound
from Barcelona
since 1972*

Contents

1.	Introduction	4
2.	Three subwoofer configurations	5
2.1.	Horizontal array (Omnidirectional)	6
2.2.	Horizontal array (Cardioid)	8
2.3.	End-fire (Cardioid)	10
3.	Six subwoofer configurations	11
3.1.	Horizontal array (Bi-directional)	12
3.2.	Horizontal array in arc (Bi-directional)	14
3.3.	Horizontal array (Cardioid)	16
3.4.	Spaced horizontal array (Super cardioid)	18
3.5.	Stereo array with end-fire	20
3.6.	Stereo cardioid array	22
4.	8 subwoofers configurations	23
4.1.	Horizontal array (Bi-directional)	24
4.2.	Horizontal array in arc (Bi-directional)	26
4.3.	Horizontal array (Cardioid)	28
5.	12 subwoofer configurations	29
5.1.	Horizontal array (Bi-directional)	30
5.2.	Horizontal array in arc (Bi-directional)	32
5.3.	Horizontal array (Super cardioid)	34
5.4.	Spaced horizontal array (Hyper cardioid)	36
5.5.	Stereo cardioid array	38
ANNEX	– Stereo cardioid array	40

1. Introduction

A subwoofer array is a set of two or more subwoofers placed each one close the other in order to improve the sub bass response of the system, i.e. adapt the directivity of the sound system to the acoustical requirements of the venue.

In this document we will show some basic subwoofer array configuration and other ones that are more elaborate. The target here is to make easy choosing a configuration once understood the requirements of the application. All the simulations shown here are theoretical (But we have confirmed the performance in in-field tests), many factors can change the configuration's performance. For all the simulations we used an Amate Audio Xcellence X218WF. In Annex 1 the details used for the simulation in EASEFocus3 are discussed. All simulations are made with a centre frequency of 50Hz and a 1/3 octave bandwidth.

Also, to provide a basic understanding of the underlying acoustics, in Annex 2 we have outlined the acoustic and sound engineering concepts referred to in this guide.

The working principle of the subwoofer arrays is their complex summation. Placing the subwoofers in the correct position will result in a constructive interference in the areas we would like to have increased sound pressure level and destructive interference where we would like to have minimum sound pressure level.

All the simulations in this project have been done with the **EASE Focus 3** software with the Amate Audio speaker libraries.

In each simulation we added pictures describing the physical arrangement of the subwoofers. Also, the delays and presets used for each subwoofer. All graphics are generated for a representative frequency of 50 Hz

The blueprint for our venue will be:

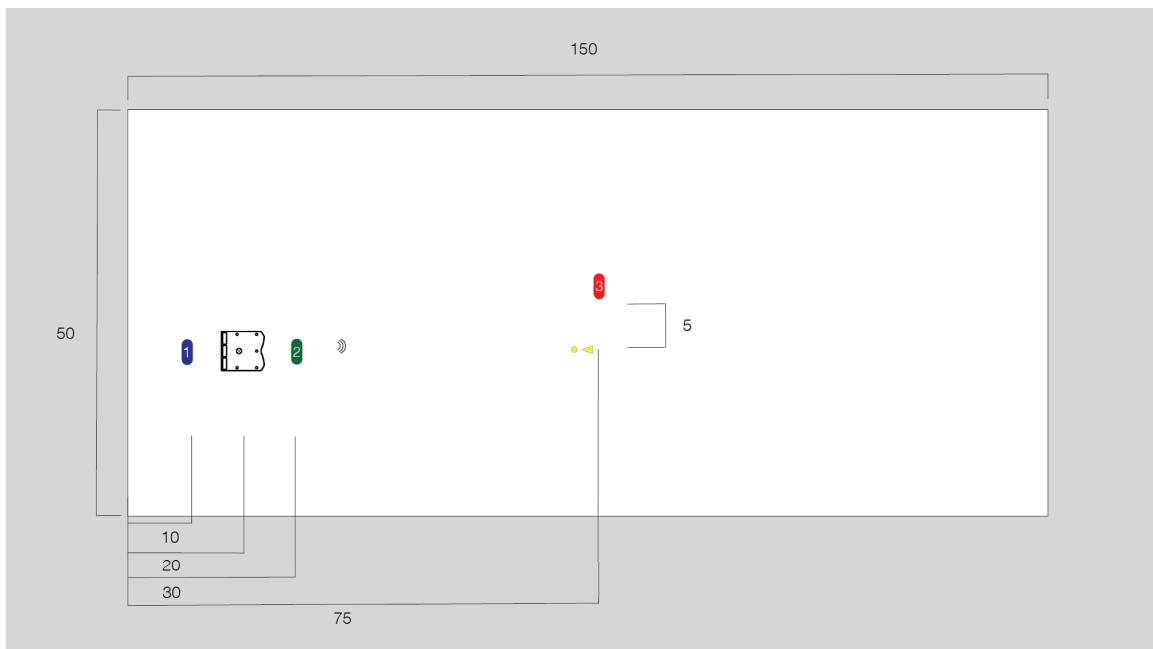

All the receivers are at height of 1.7 meters. We placed them with the following purpose:

- 1.** The first receiver, in blue, represents the near-field in the back of the subwoofers. Usually, where we wouldn't like to have sound.
- 2.** The second receiver, in green, represents the near-field in the front of the subwoofers. This is useful to check the front-to-back attenuation for cardioid configurations.
- 3.** The third receiver, in brown, represents the off-axis far field.

We are going to show the results using the representation of both the absolute sound pressure level and the relative one. The absolute sound pressure representation shows the SPL in each point in the venue.

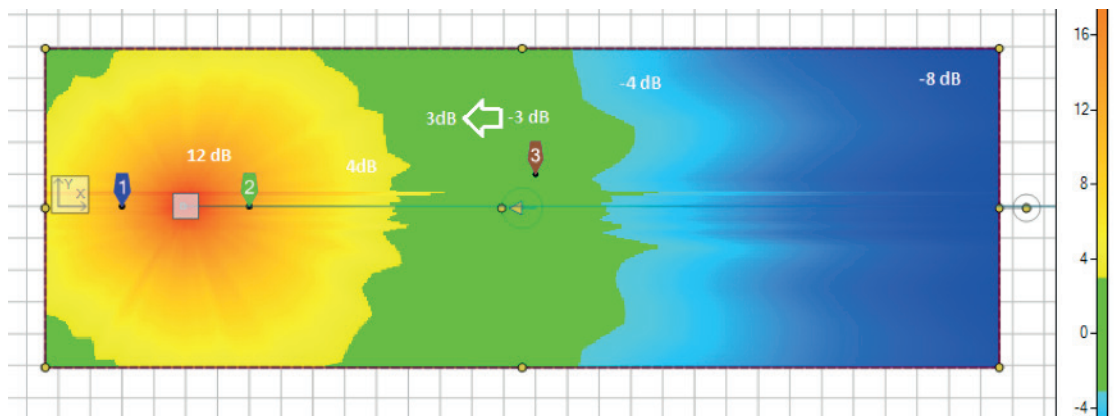

The relative sound pressure level representation is a bit harder to understand but very useful. Here what EASE Focus 3 is doing is assign the green colour to the zones where the SPL is 3 dB above or below the mean SPL in the entire venue (the ideal target). Warmer colours are assigned to the zones with more than a +6dB of deviation from the mean SPL so zones with a very high of sub bass presence. Colder colours are assigned in the zones where the SPL decays.

Let's see an example:

2. Three subwoofer configurations

2.1 Horizontal array (Omnidirectional)

This configuration is ideal in those applications where we simply need an increased sound pressure level we can't get with a single subwoofer.

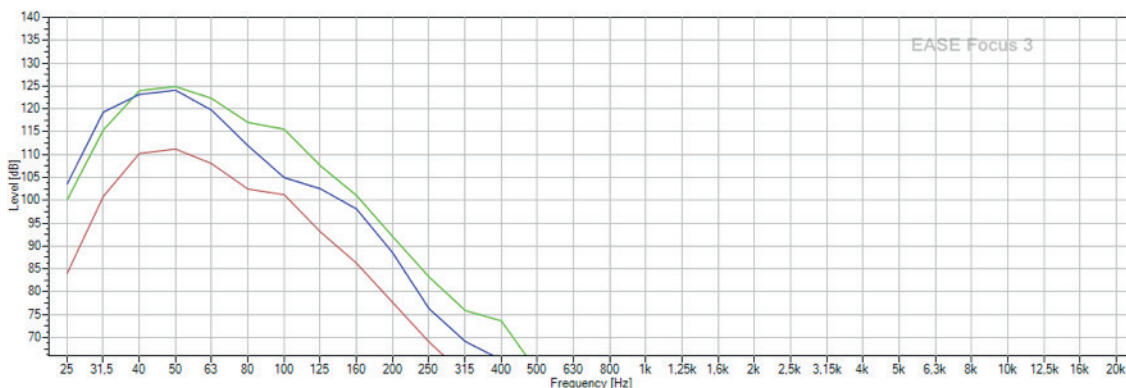
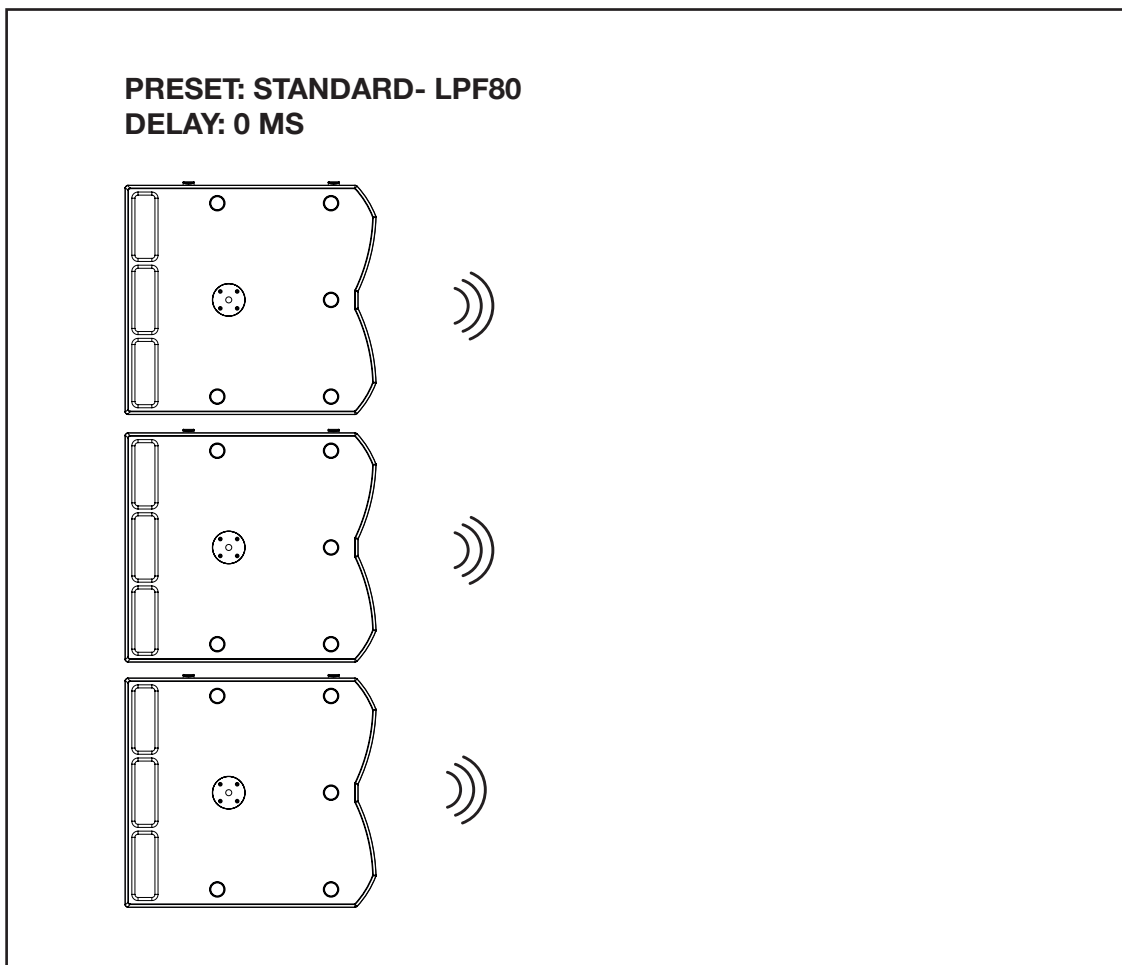

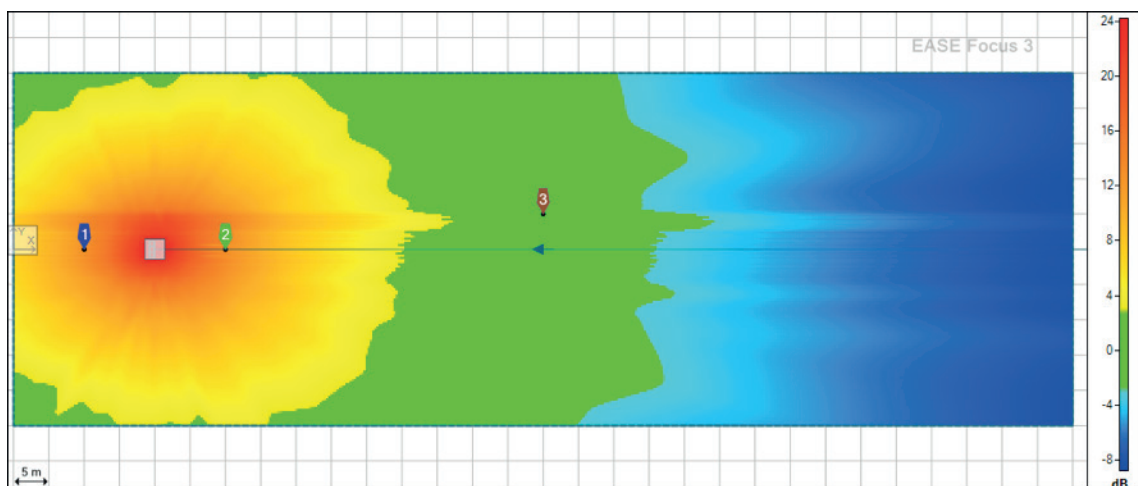
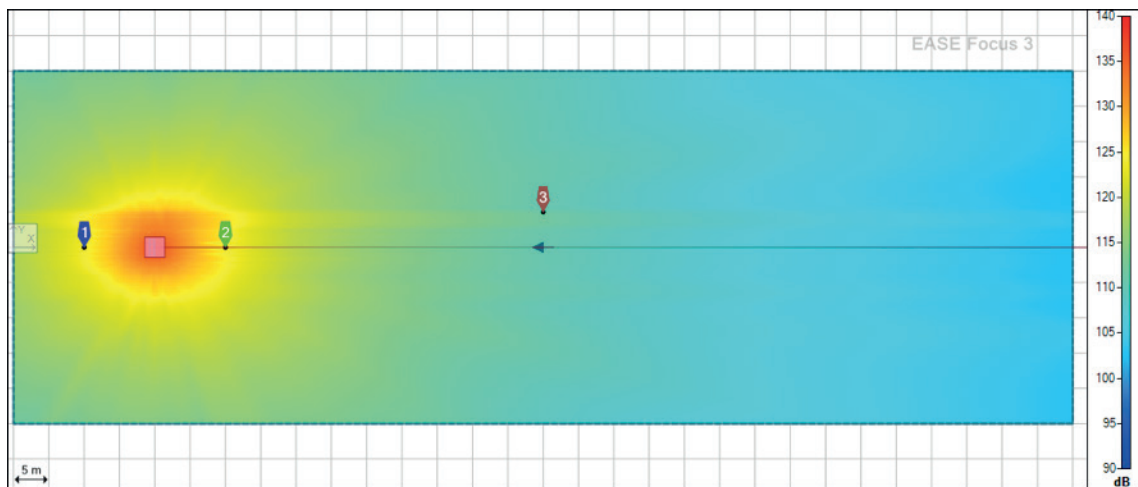

We can see in the simulation how indeed the three subwoofers directivity is omnidirectional. Looking at the frequency distribution chart also we can see how when increasing frequency the array is more directional, but it won't affect our system due the low pass filter of the LPF80 preset.

2.2. Horizontal array (Cardioid)

Here we are going to show our quickest set-up cardioid subwoofer array configuration. This configuration is similar to the previous one, but simply requires us to rotate the subwoofer in the middle like is shown in the diagram below. This straightforward solution is very interesting for live shows where subwoofers are placed in front of the stage.

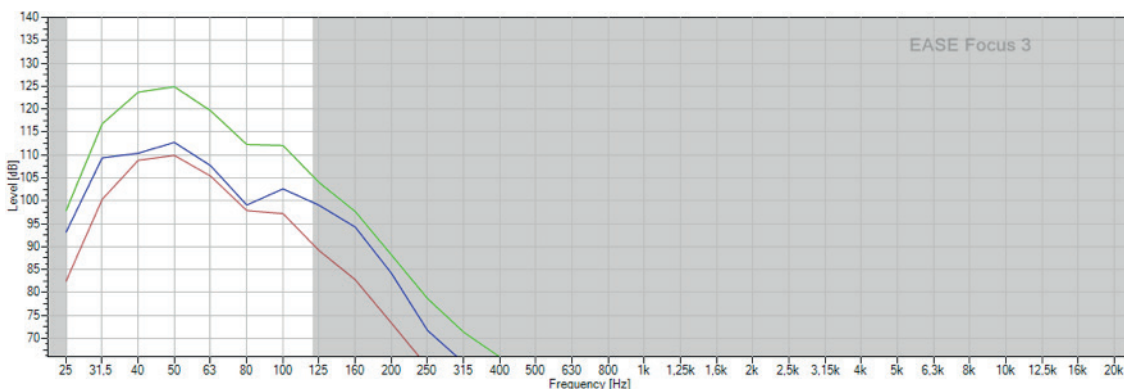
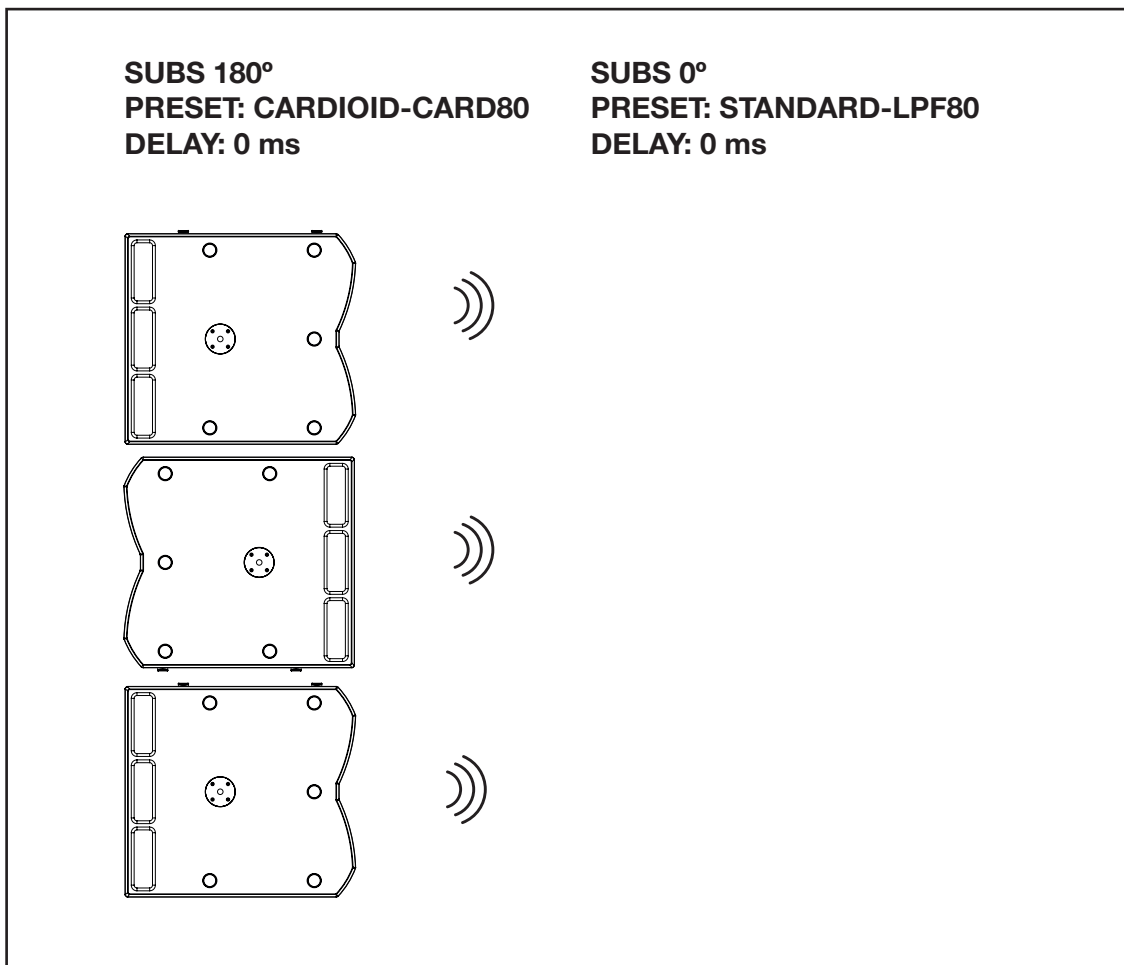

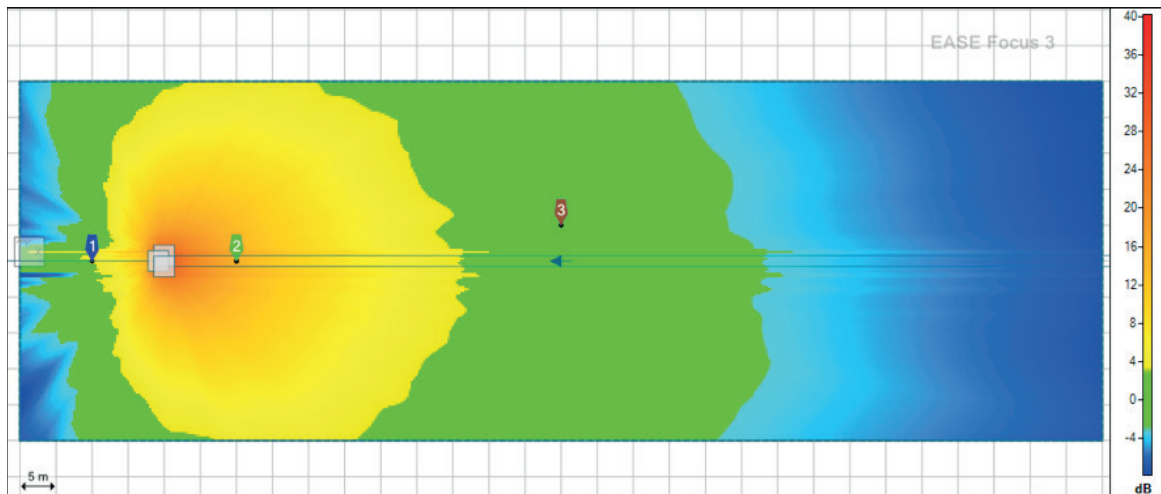
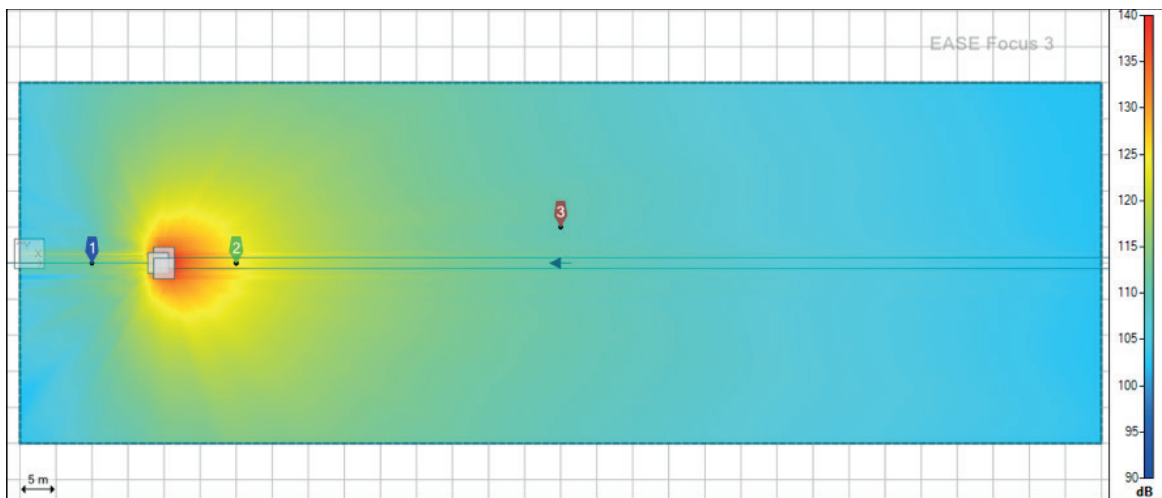

Looking the coverage response we can see clearly how now that there is a valley of sound pressure level on the rear part (receiver #1), with an increased SPL in the near-field (receiver #2).

2.3. End-fire (Cardioid)

Another alternative we have for creating a subwoofer cardioid array is the end fire, which can be done placing subwoofers one in front of the other in a straight line with the separation shown in the diagram below. This configuration has a narrower directivity that the previous cardioid configuration, with the counterpart of needing more length for doing so.

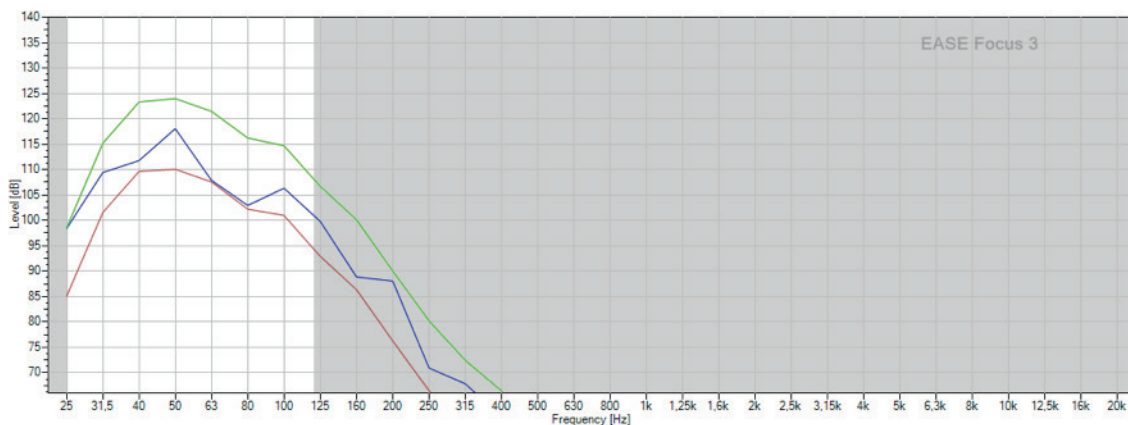
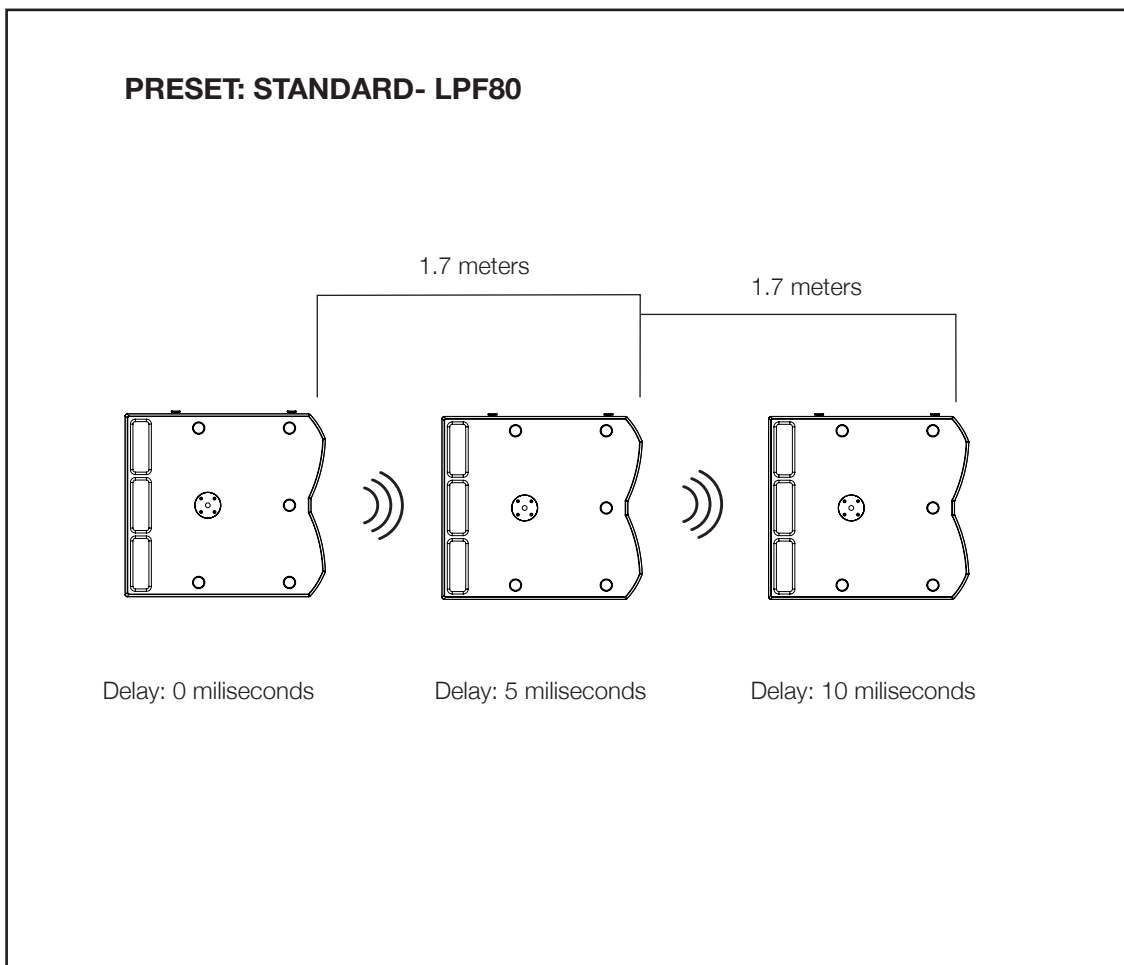

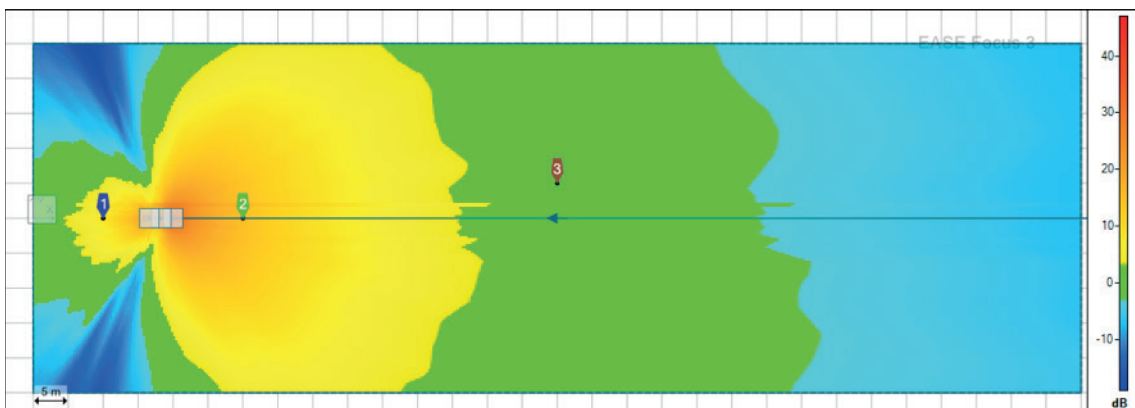
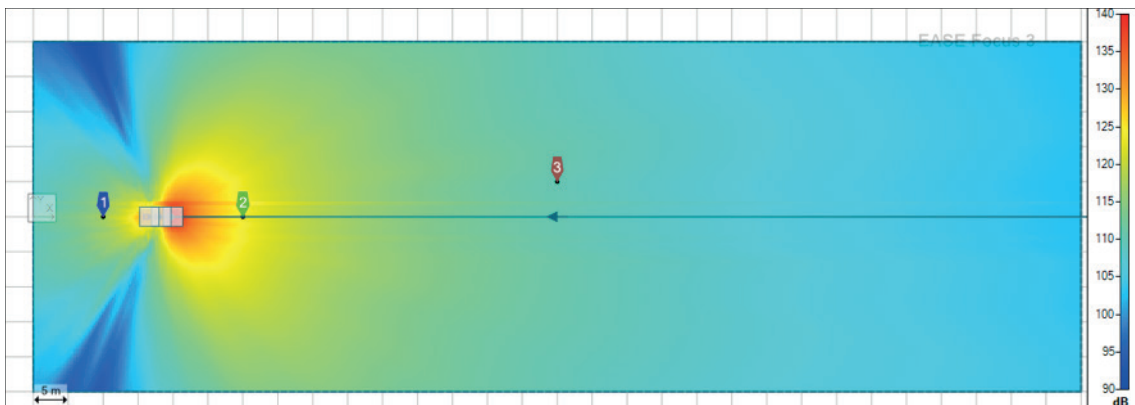

Notice that the end-fire is not a preset, so now we need to apply the corresponding delay in each subwoofer. Set the preset to the default one

3. Six subwoofer configurations

Now we're going to show more advanced configurations using six subwoofers, with an increased performance.

When increasing the number of subwoofers in the configuration of a horizontal subwoofer array, the distance between subwoofers is critical. This is because this distance is limited by the maximum frequency to be reproduced. Beyond this frequency the phenomenon of destructive interference starts to happen where we don't want it to happen (in front of the subwoofers), so the distribution of frequency in all the audience area is not equal: i.e. bad sound quality. We can notice this effect happening when walking around the audience area, the sub-bass balance and feeling will go from slight noticeable to excessive, like the sound engineer is connecting and disconnecting the subwoofers. This maximum distance corresponds to half of the wavelength of the frequency limit we want. For 100Hz the distance is 1.7 meters.

3.1 Horizontal array (Bi-directional)

When placing several subwoofers side-by-side, each speaker interacts with each other speaker, forming a bi-directional polar pattern; i.e. there is the same sound pressure in the front of the horizontal array that in back but lower level in the sides of the array. Also directivity is very high, later we will see how to control this natural narrow directivity.

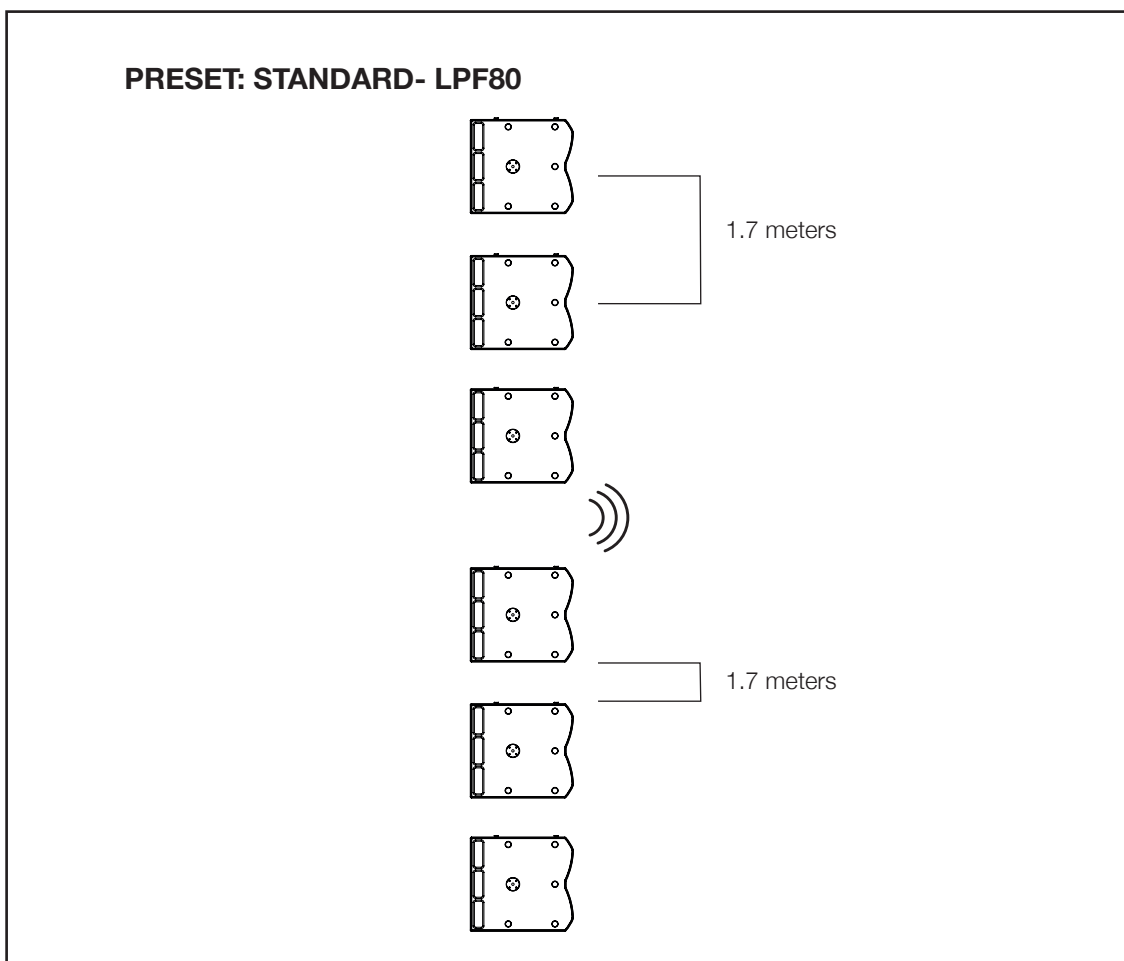

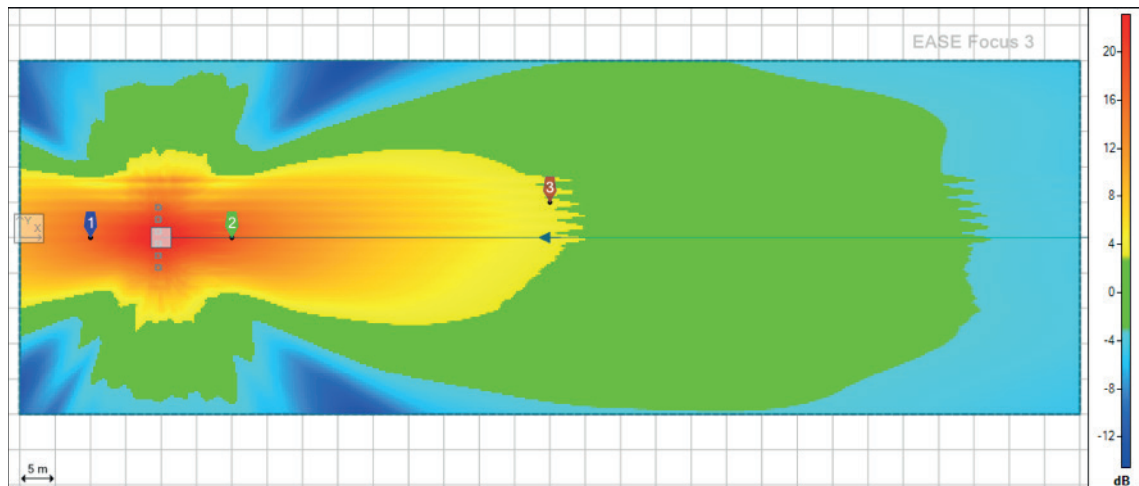
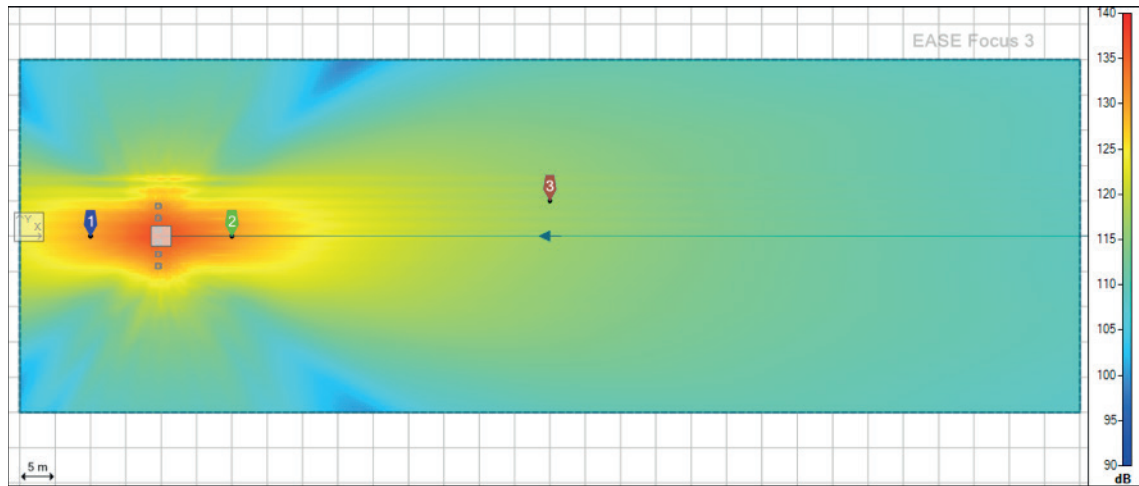
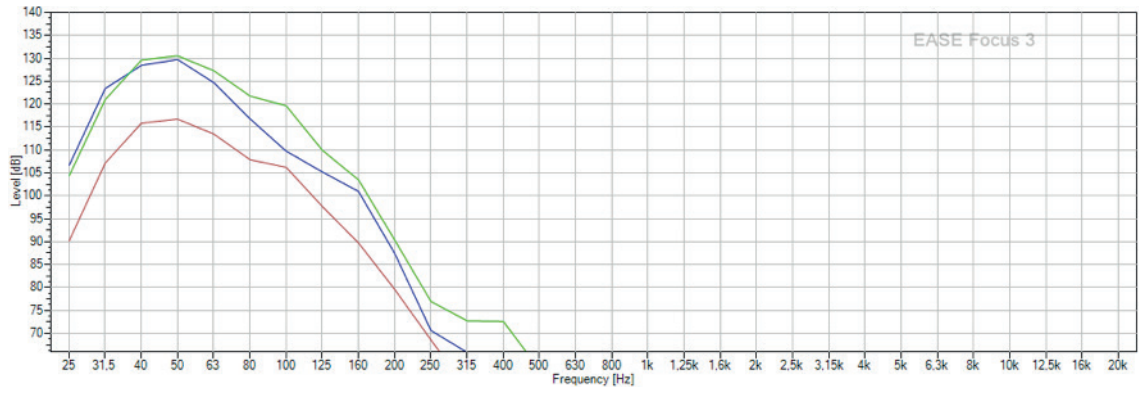

We can see in the simulations how we achieve a big area of even distribution of sound pressure level, but with the same SPL in the back of the array.

3.2. Horizontal array in arc (Bi-directional)

Keeping the same arrangement than in the previous section, there is the possibility of adding certain delay in each subwoofer so we can control the directivity of the array in order to distribute better the SPL in all the audience area. This is exactly the same that putting the subwoofer in arc formation. These delays are calculated by EASE Focus 3 once we set a coverage angle. For 60 degrees of coverage angle we get these delays:

Box Locations & Delays					
#	X [m]	Y [m]	Z [m]	Delay [ms]	Total Delay [ms]
1	0,00	-4,25	0,00	3,3	3,3
2	0,00	-2,55	0,00	0,7	0,7
3	0,00	-0,85	0,00	0,0	0,0
4	0,00	0,85	0,00	0,0	0,0
5	0,00	2,55	0,00	0,7	0,7
6	0,00	4,25	0,00	3,3	3,3

Filter Settings	
Input Configuration	STANDARD
XOVER	LPF80

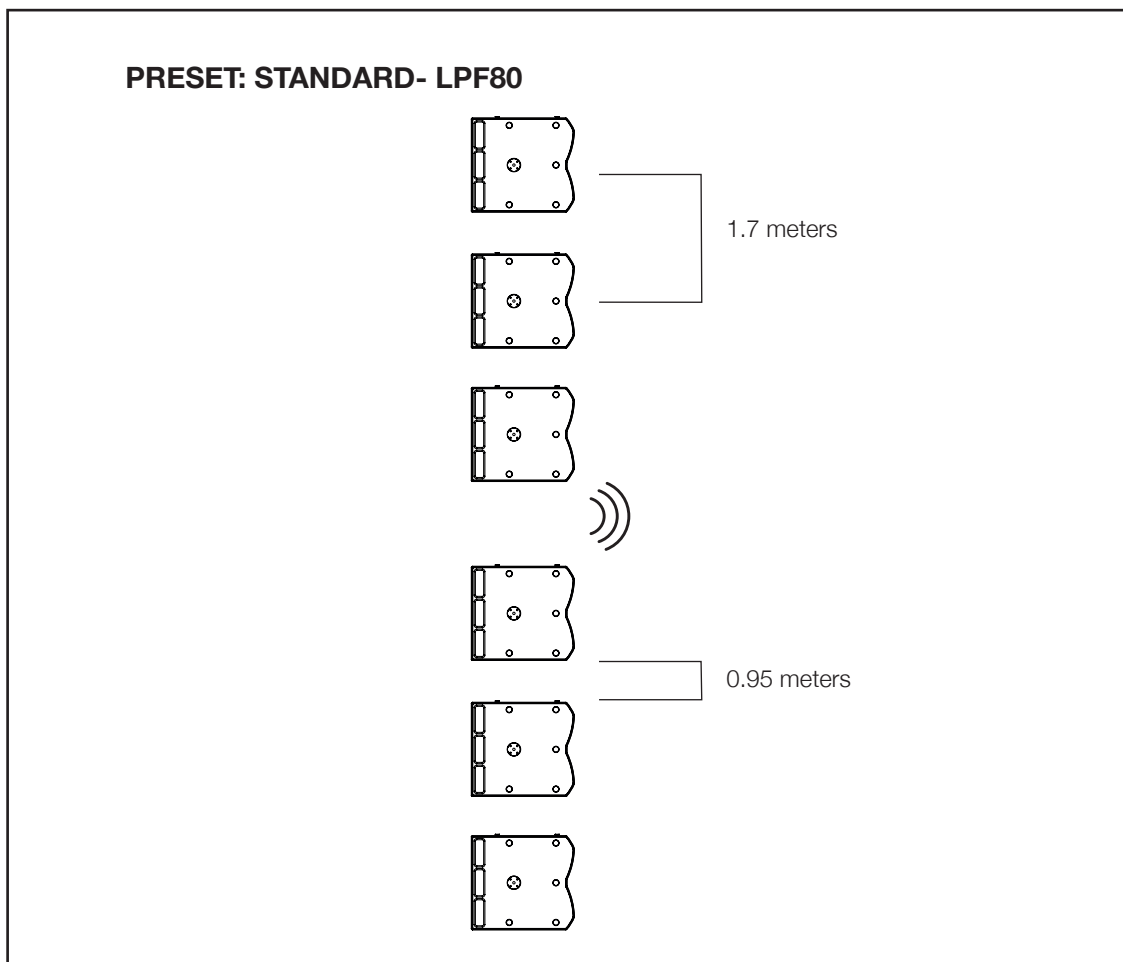

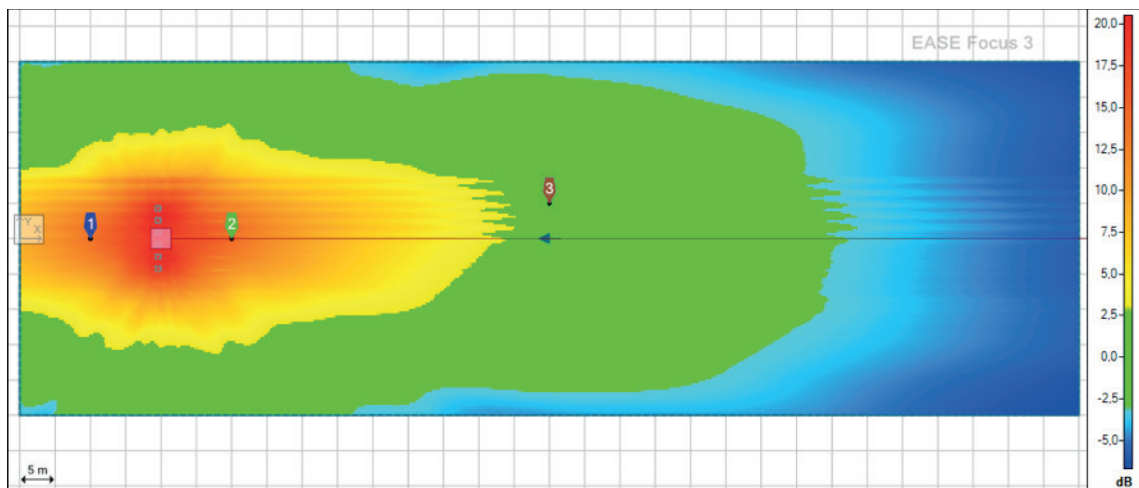
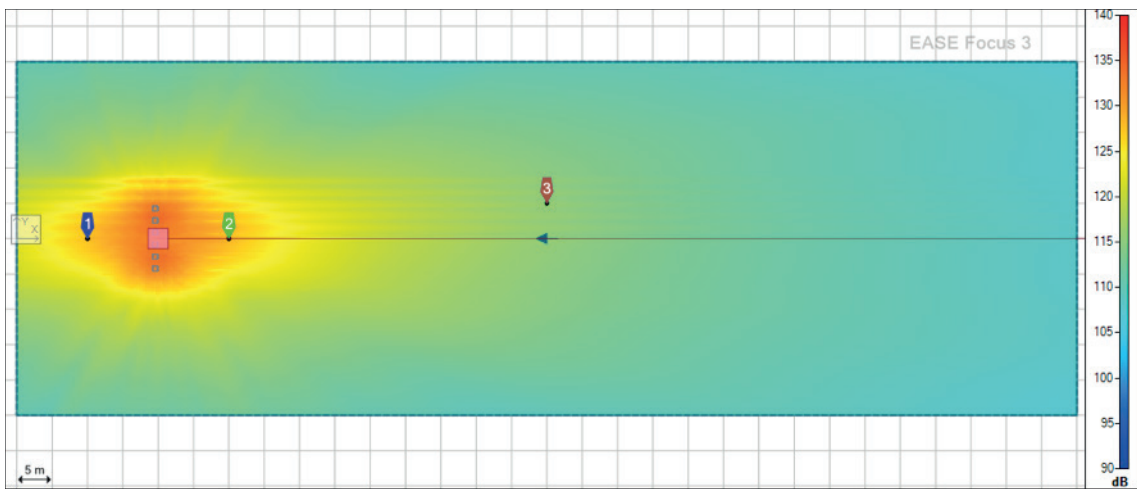
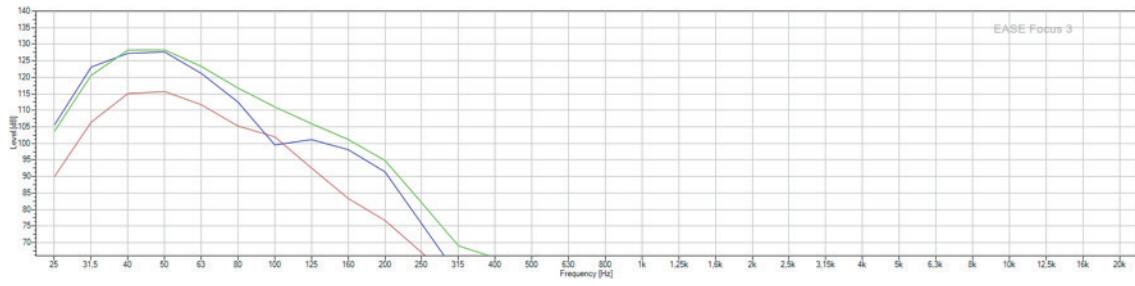

3.3 Horizontal array (Cardioid)

This array is an extended version of the 3 subwoofers cardioid. Notice the formation is created by placing two clusters of 3 subwoofers cardioid near one another.

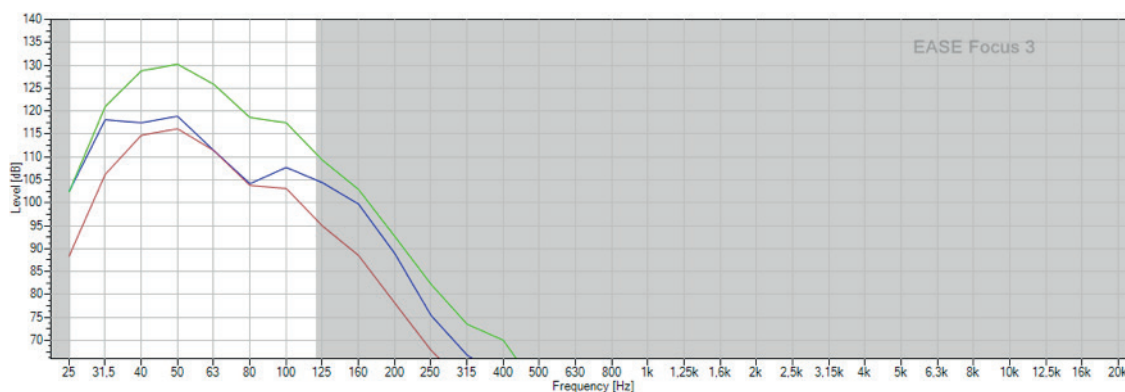
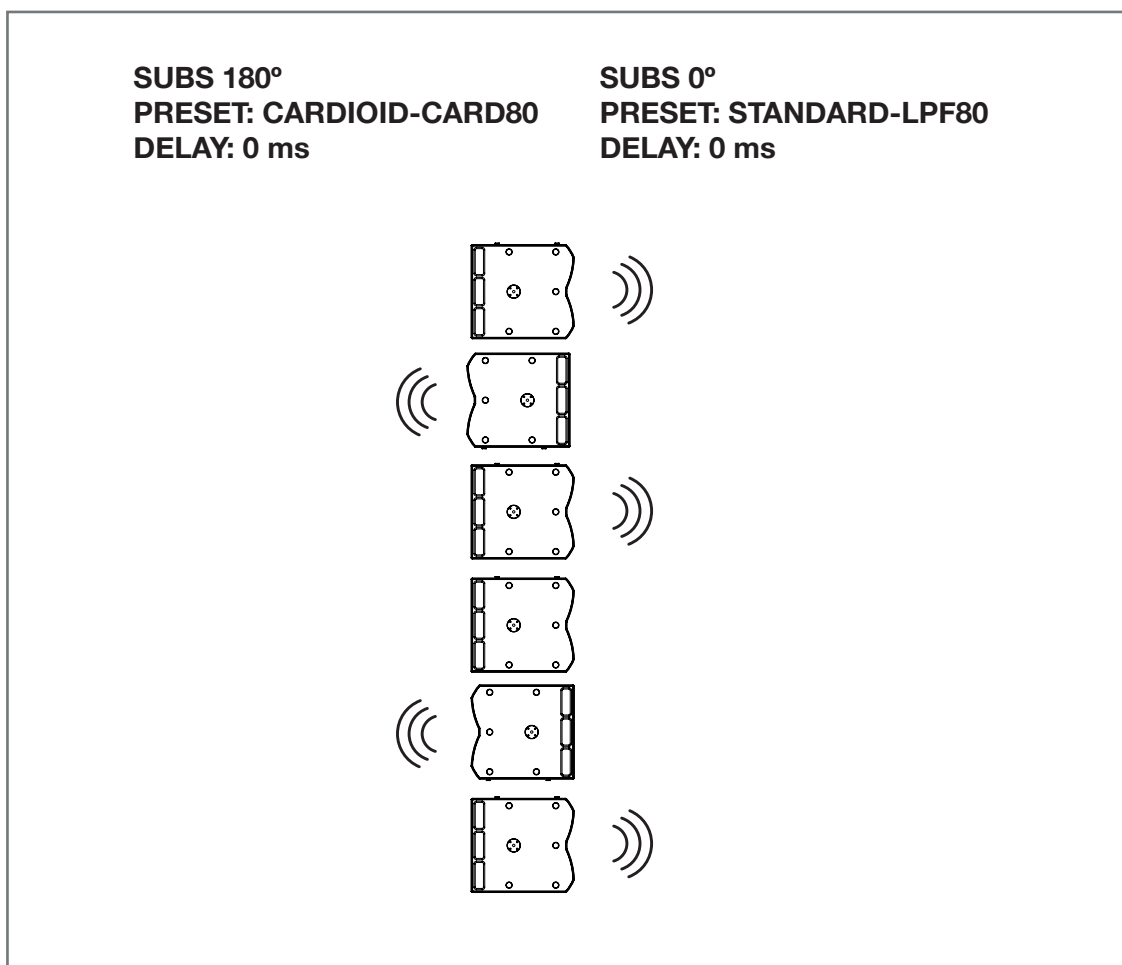

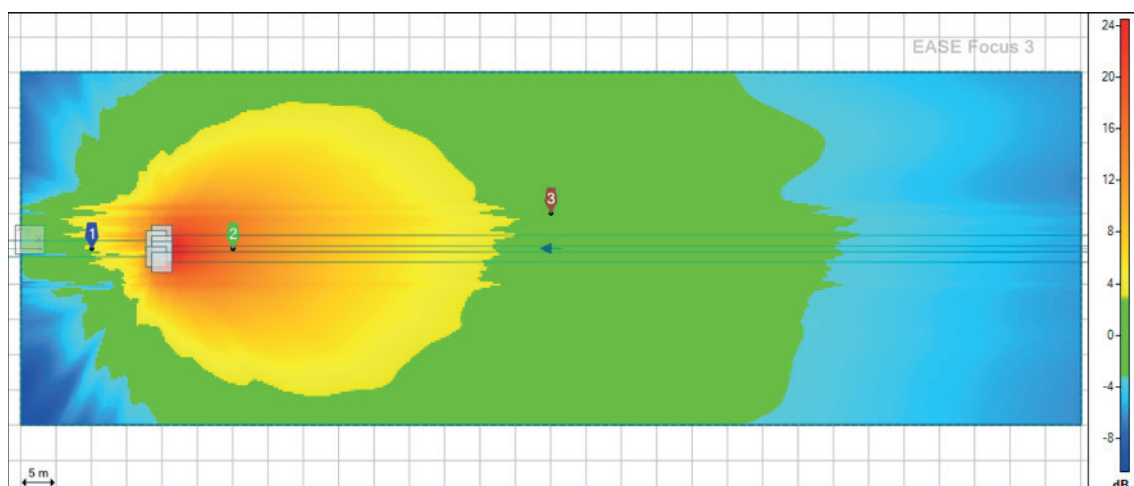
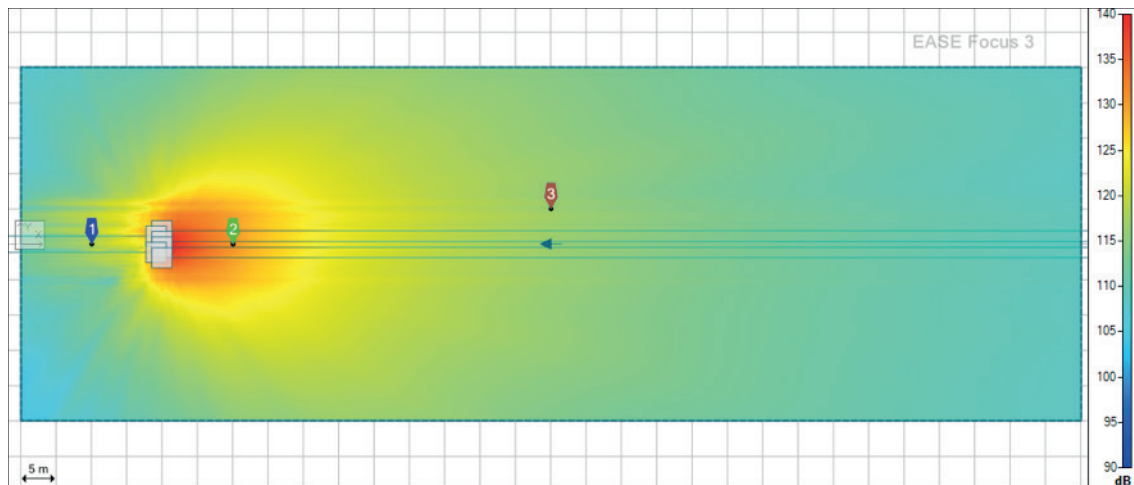

We can see how we get an improved version of the 3 subwoofers cardioid array, but we still get high SPL in the sides of the audience area. In the following section we are going to offer an alternative of this configuration for distributing better the SPL in the audience zone of this venue.

3.4 Spaced horizontal array (Super cardioid)

With a specific spacing between the clusters, we can increase the directivity of the array in a way we can optimize the distribution of SPL in our example audience area. Exactly as is happening in the subwoofer horizontal array, this distance between clusters is critical and in any case cannot be more than 2.44 meters, as shown in the diagram below. Lesser spacing decreases the directivity.

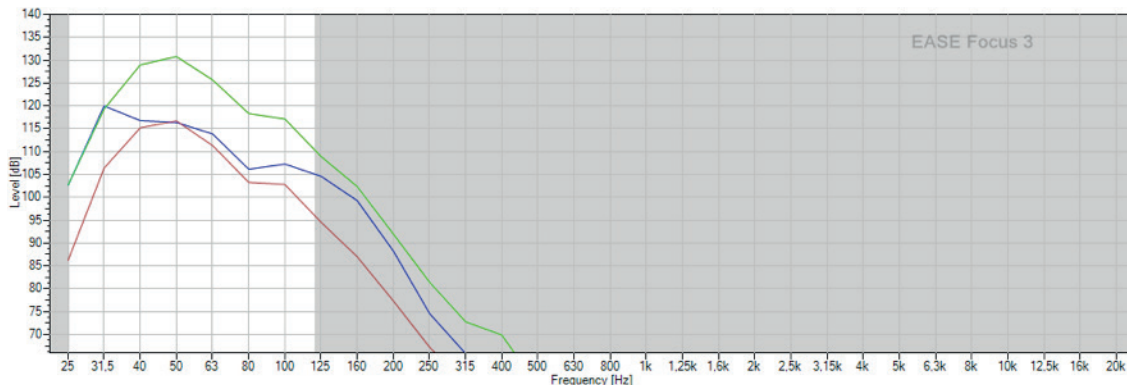
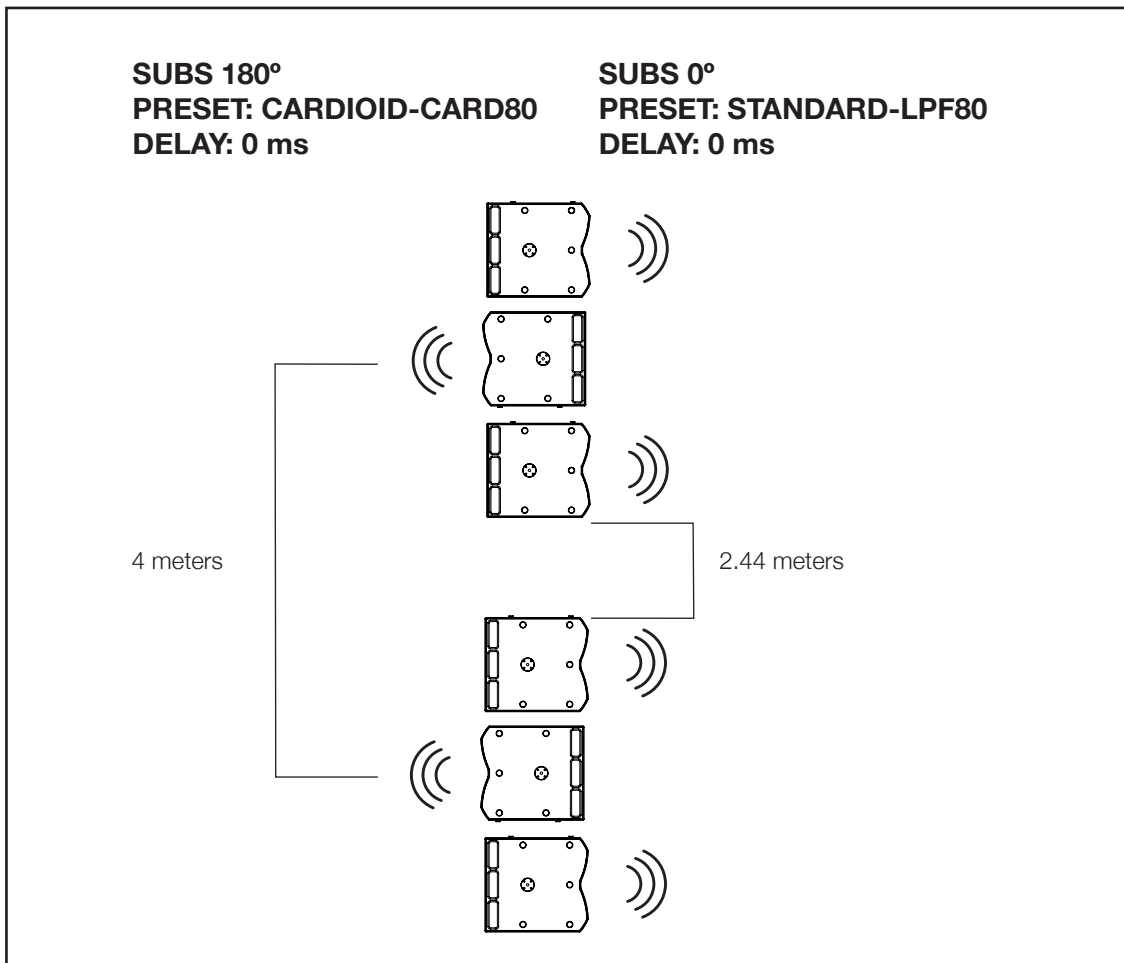

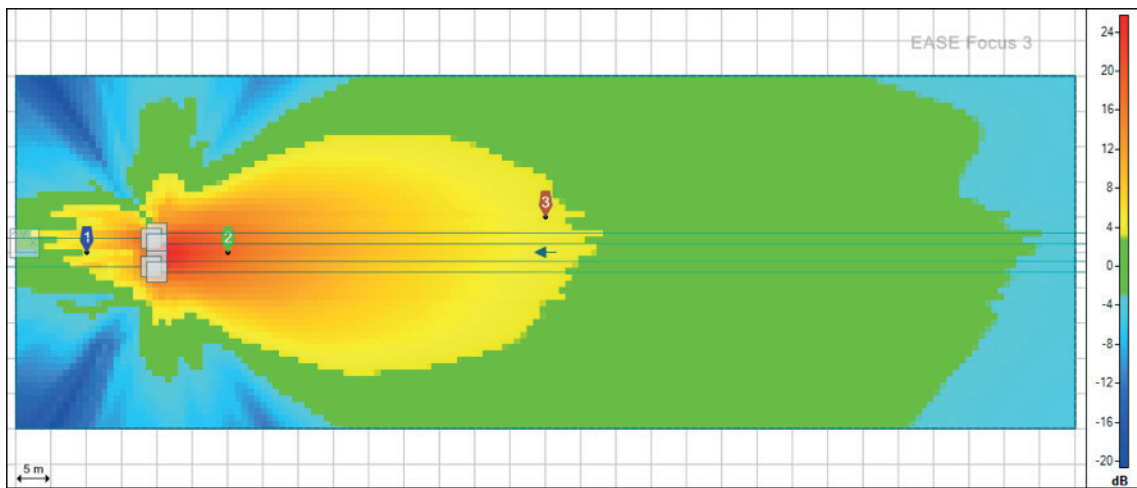
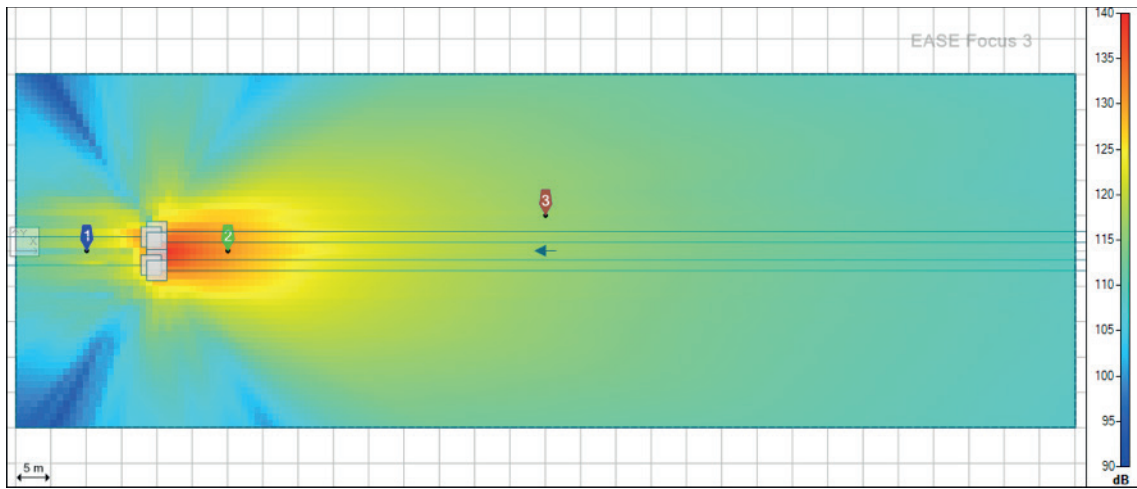

It is clearly shown how with this configuration we can cover a larger area.

3.5 Stereo array with end-fire

Doing the L-R stereo subwoofer configuration is not recommended because we will get an irregular frequency distribution throughout the audience area. There is no way of avoiding this effect. Each cluster will interact with the other (even in L-R configuration), like in the previous configurations and, as we saw with more than a half wavelength of separation, we get in trouble with frequency response.

We chose to start with end-fire, due its high directivity and since intuition might suggest that with high directivity we might avoid creating irregular frequency distribution.

The result is as following:

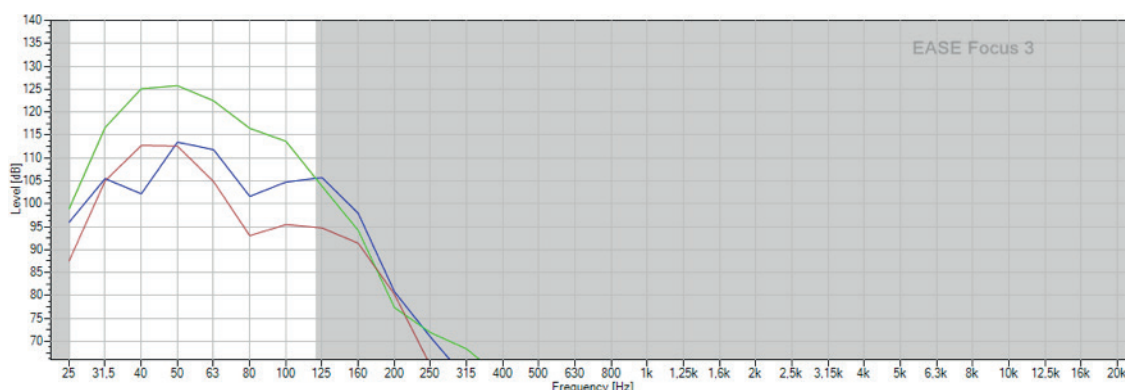
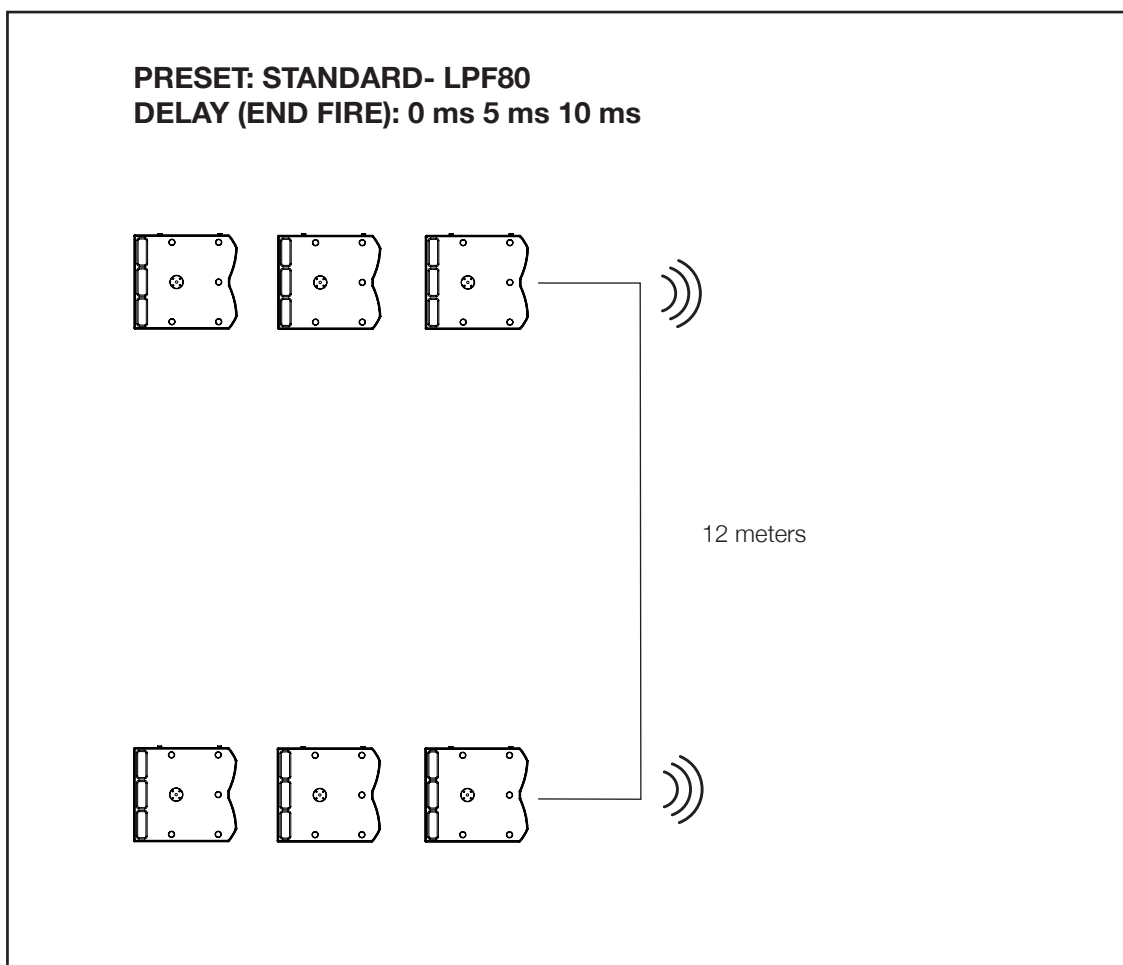

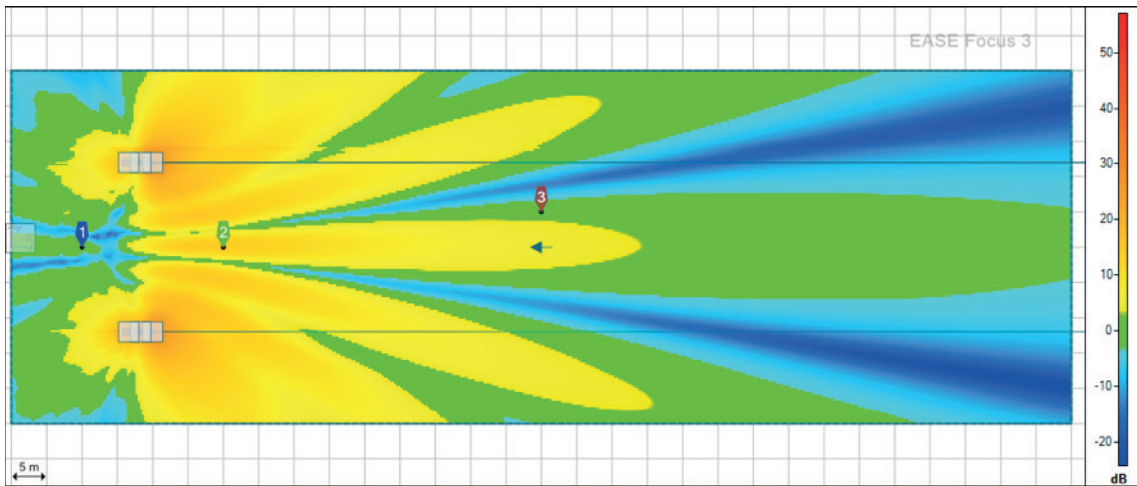
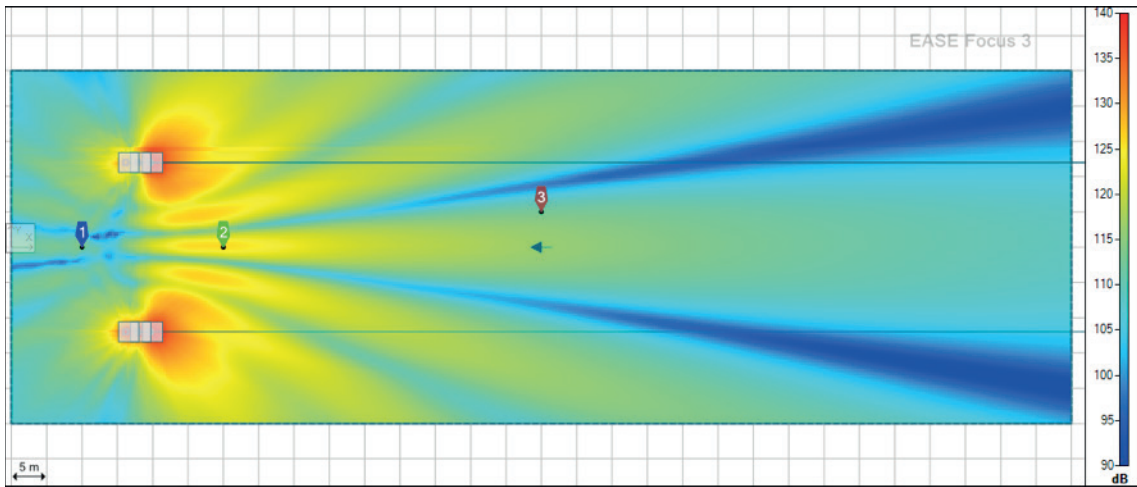

Though is this effect is not that noticeable in the frequency distribution chart, it is well shown in the venue simulation how at 50 Hz we get “corridors” with no SPL.

3.6 Stereo cardioid array

Let's try now increasing even more the distance between the subwoofers in a L-R configuration with our cardioid configuration; maybe this might improve performance.

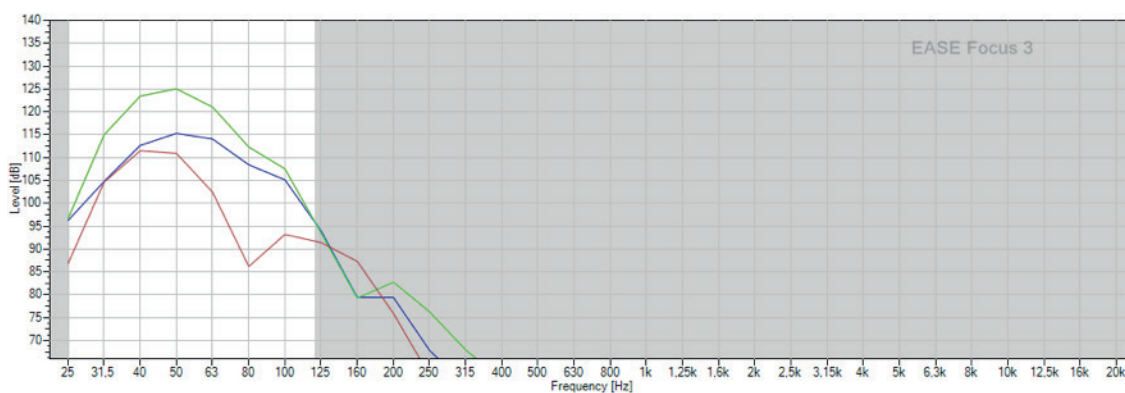
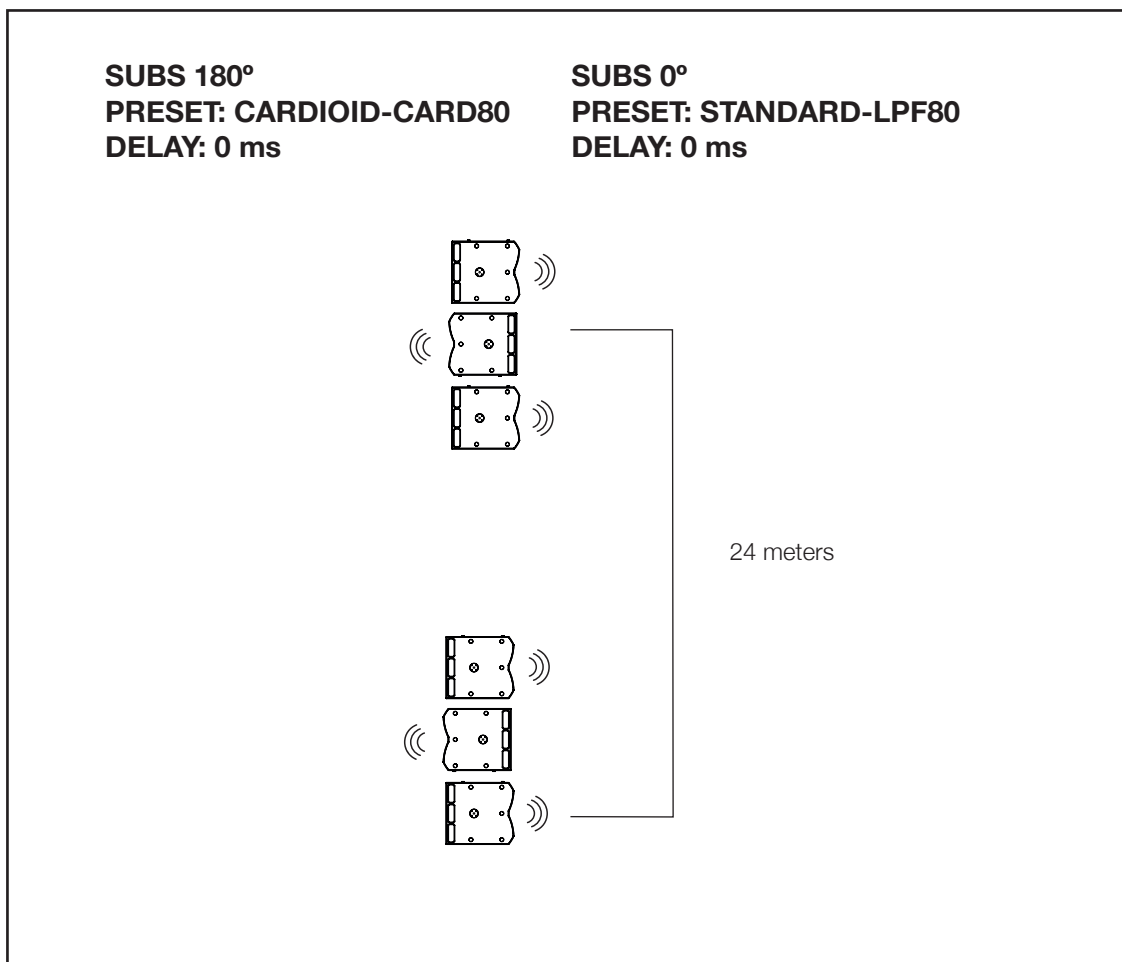

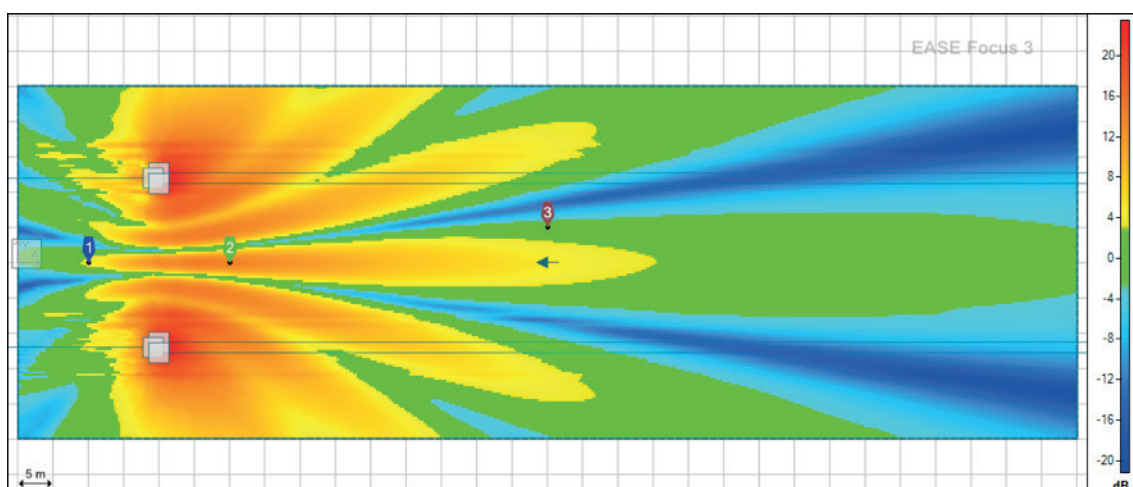
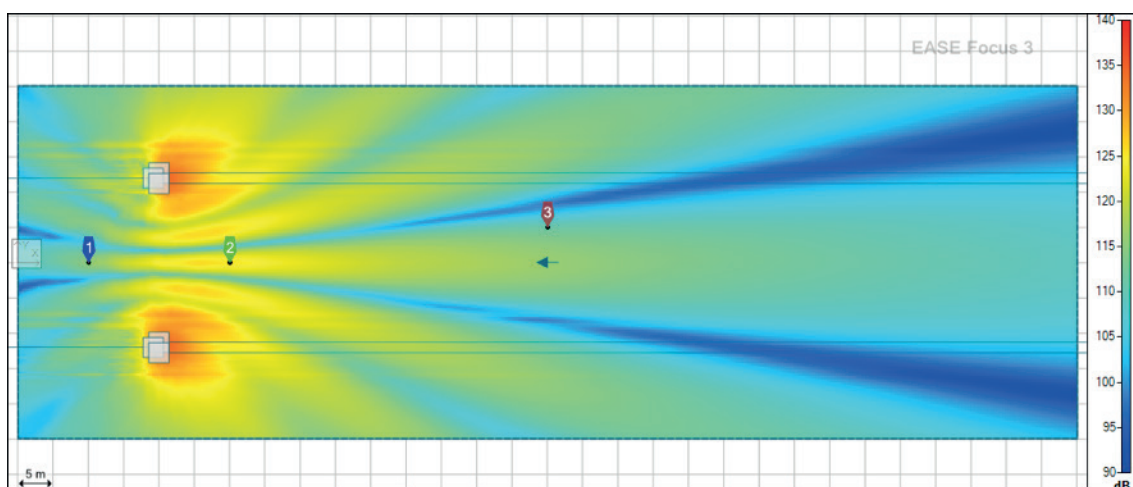

We get exactly the same effect. In all stereo subwoofer configurations we get odd frequency response. In terms of sound quality, these configurations should never be used.

4. 8 subwoofers configurations

4.1. Horizontal array (Bi-directional)

Remember the maximum spacing between subwoofers is 1.7 meters.

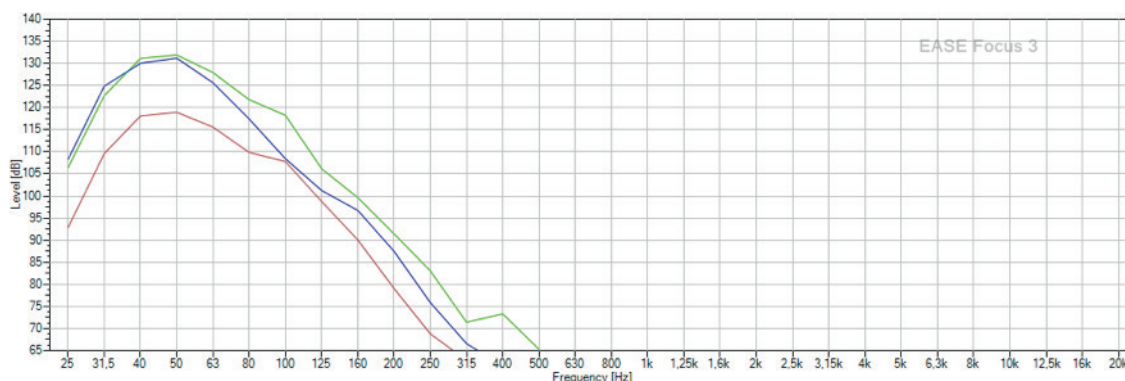
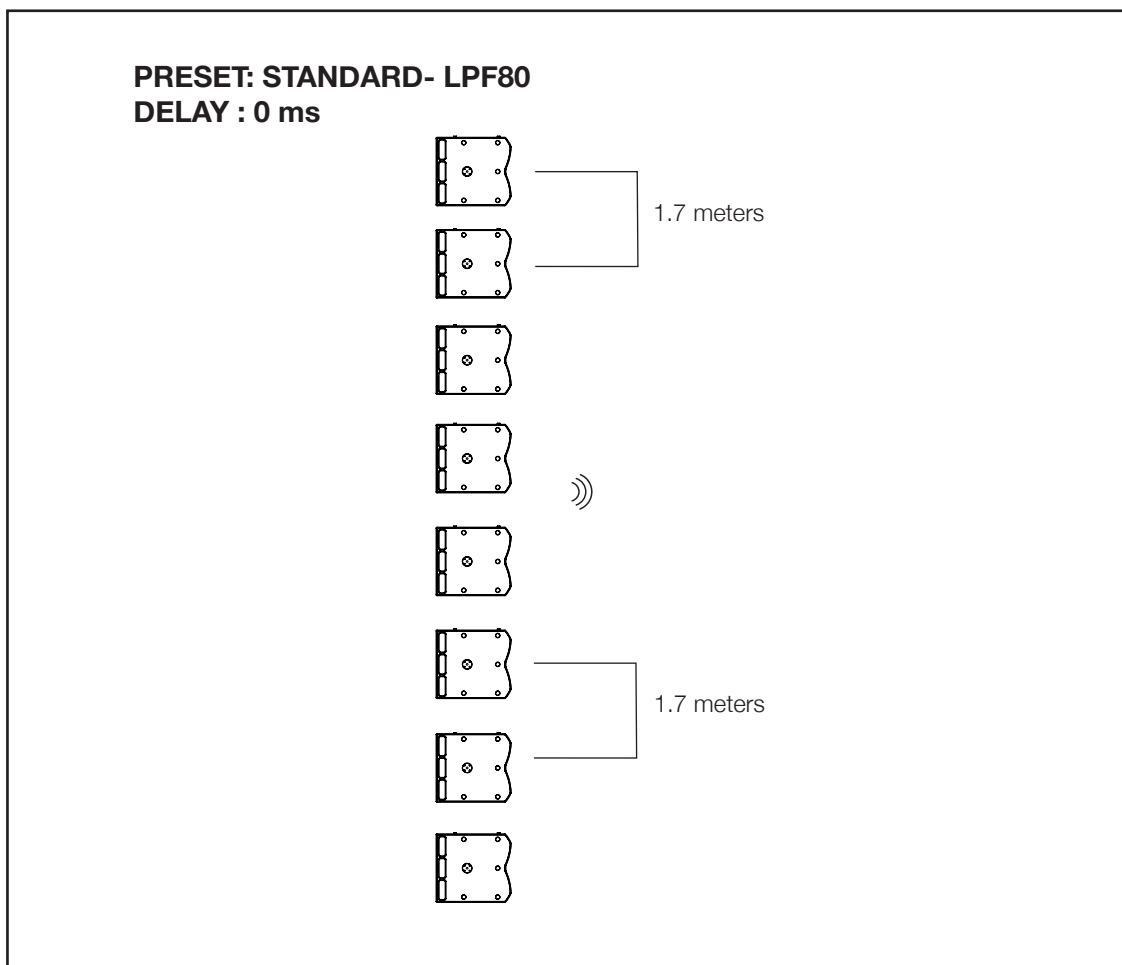

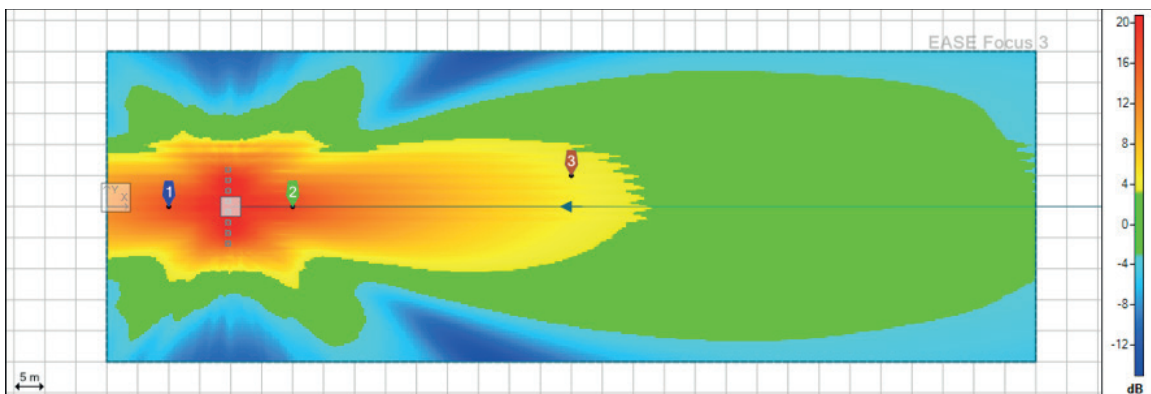
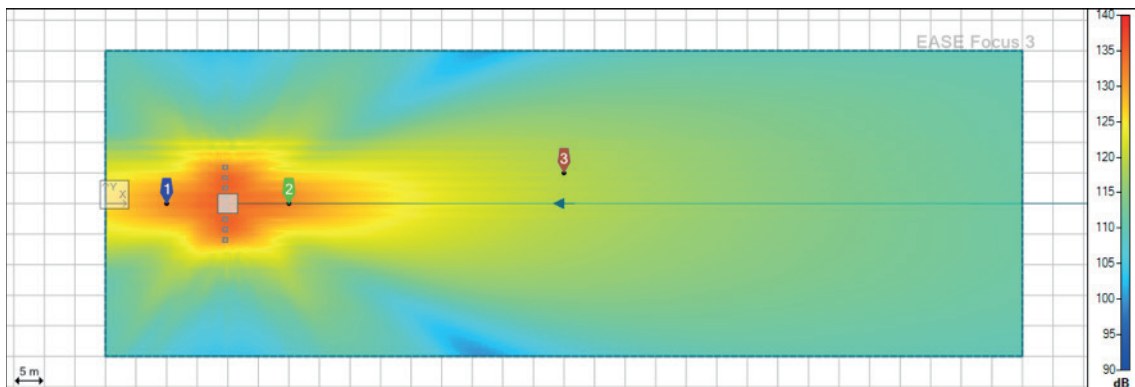

We can see again the high directivity of this configuration.

4.2. Horizontal array in arc (Bi-directional)

Box Locations & Delays					
#	X [m]	Y [m]	Z [m]	Delay [ms]	Total Delay [ms]
1	0,00	-5,95	0,00	5,4	5,4
2	0,00	-4,25	0,00	2,0	2,0
3	0,00	-2,55	0,00	0,4	0,4
4	0,00	-0,85	0,00	0,0	0,0
5	0,00	0,85	0,00	0,0	0,0
6	0,00	2,55	0,00	0,4	0,4
7	0,00	4,25	0,00	2,0	2,0
8	0,00	5,95	0,00	5,4	5,4

Filter Settings	
Input Configuration	
STANDARD	▼
XOVER	LPF80 ▼

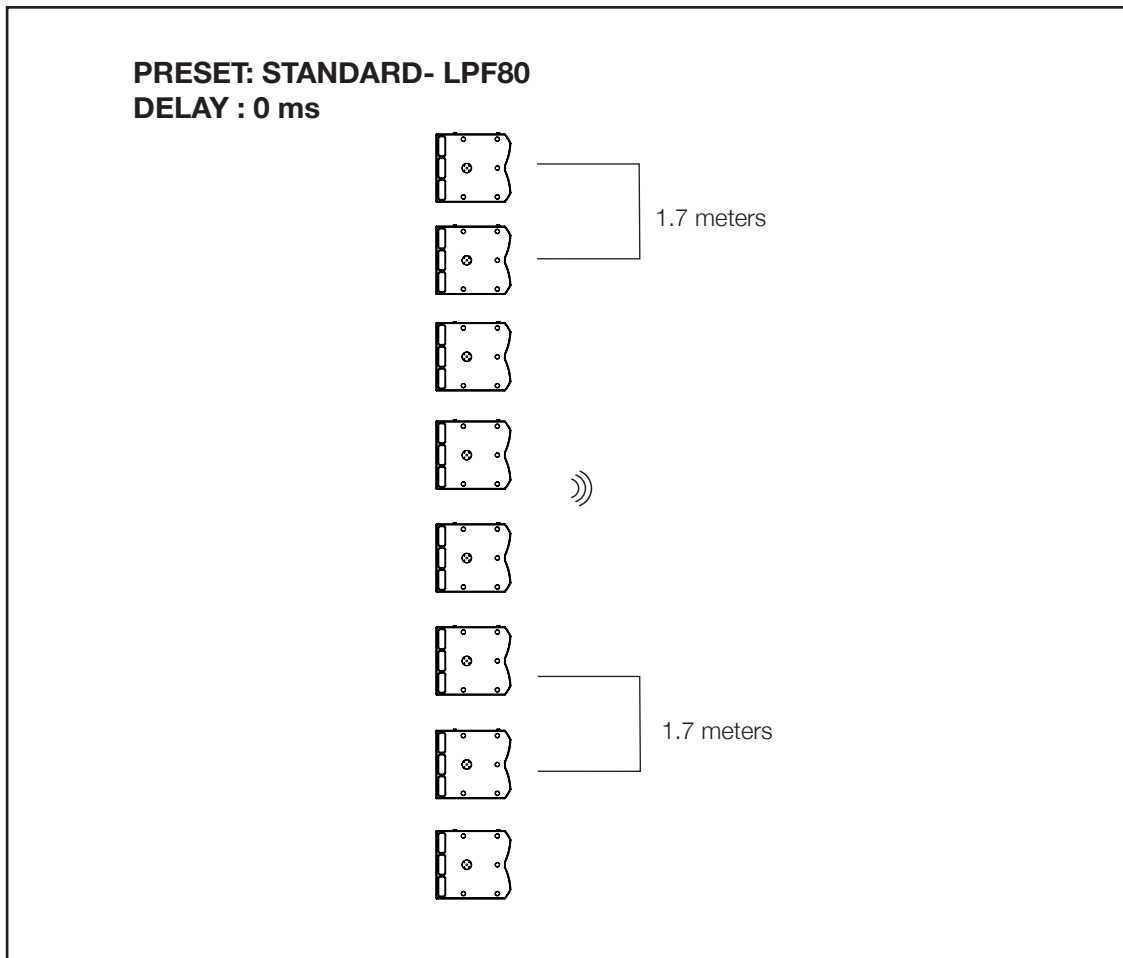

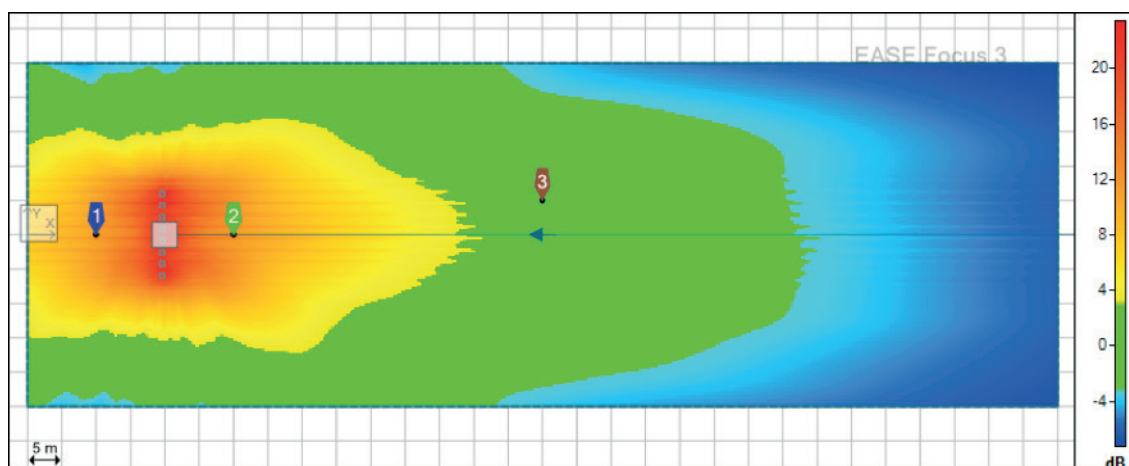
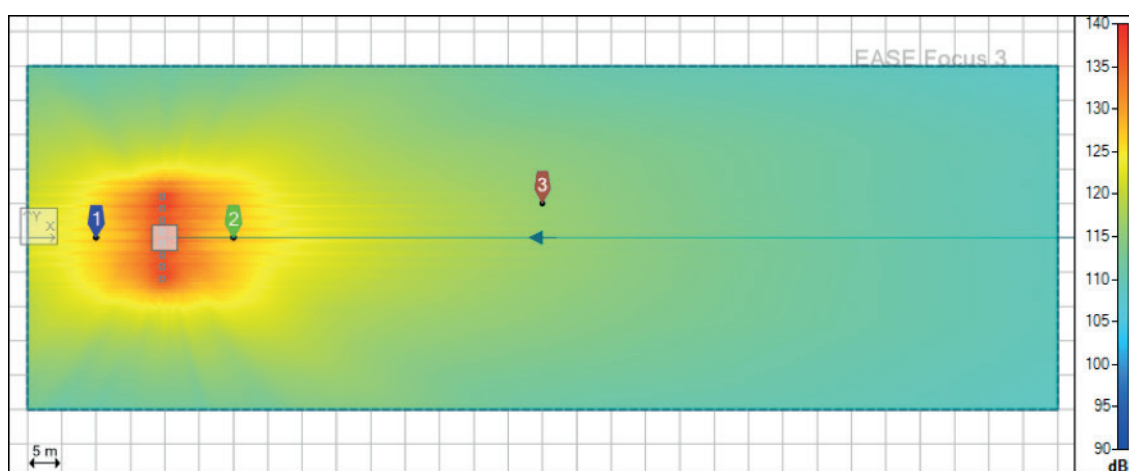
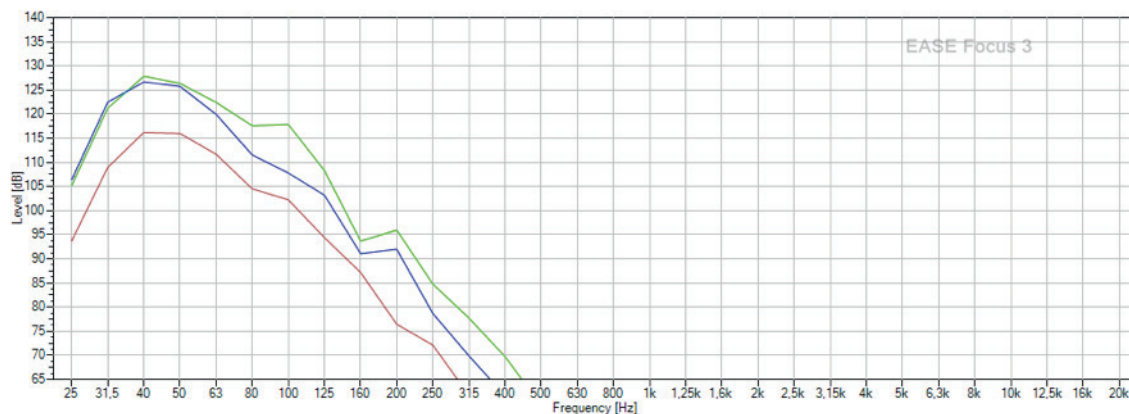

4.3. Horizontal array (Cardioid)

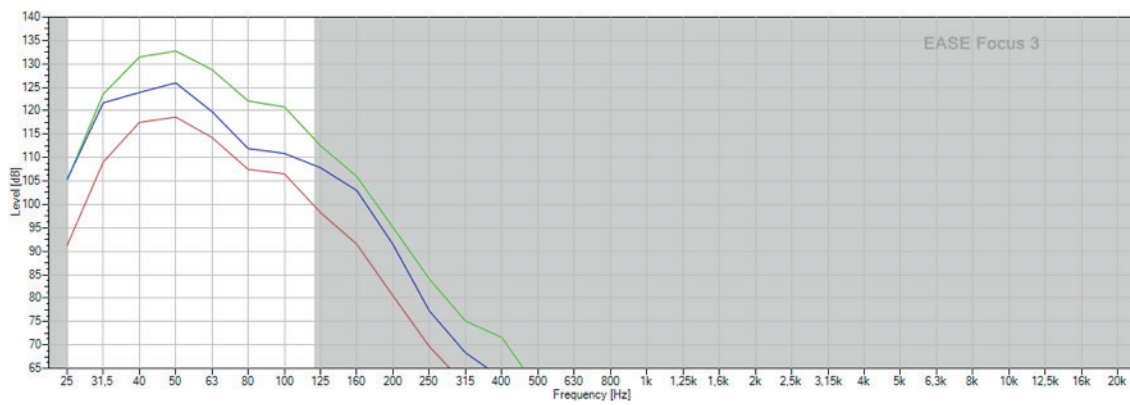
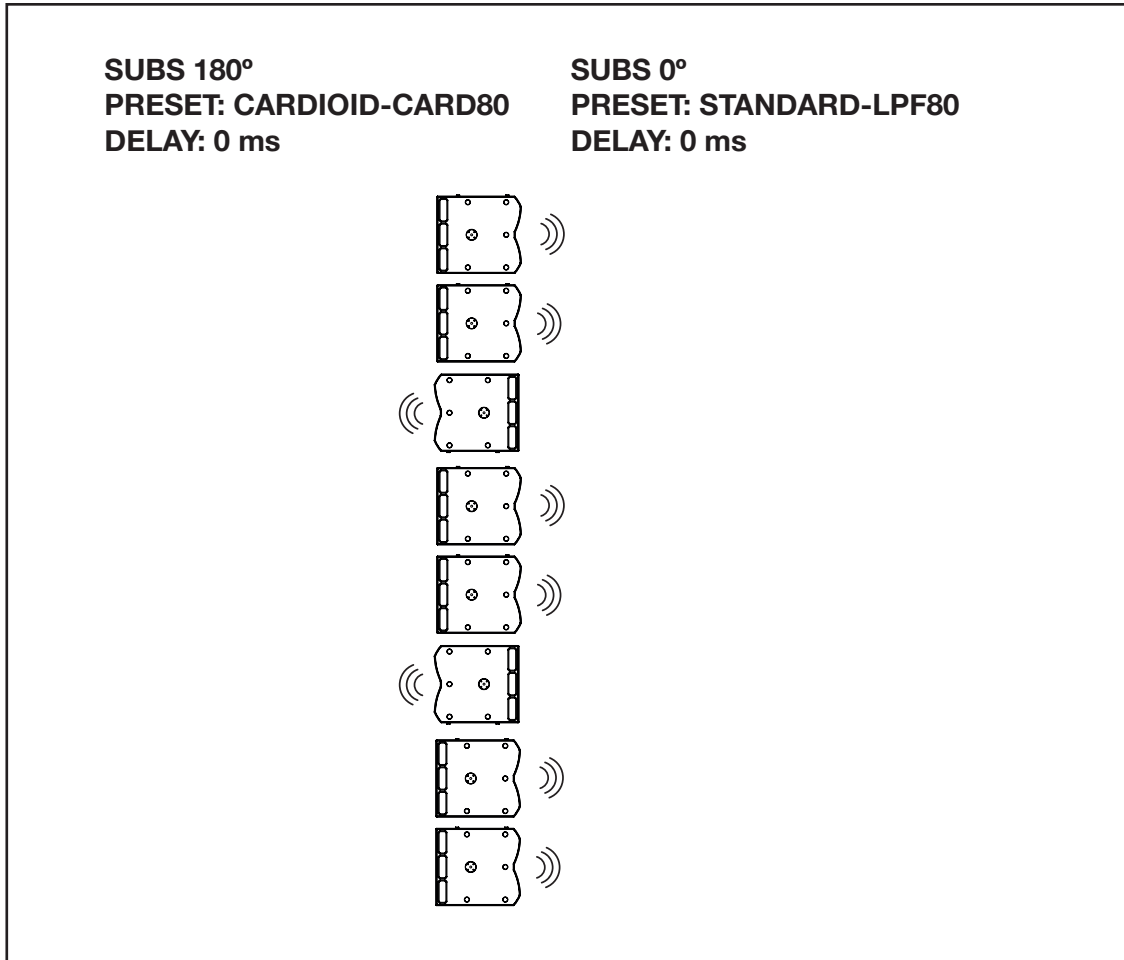

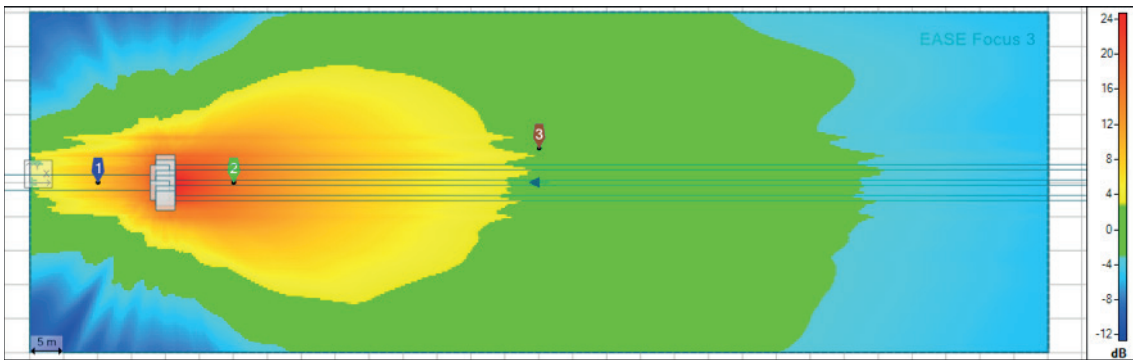
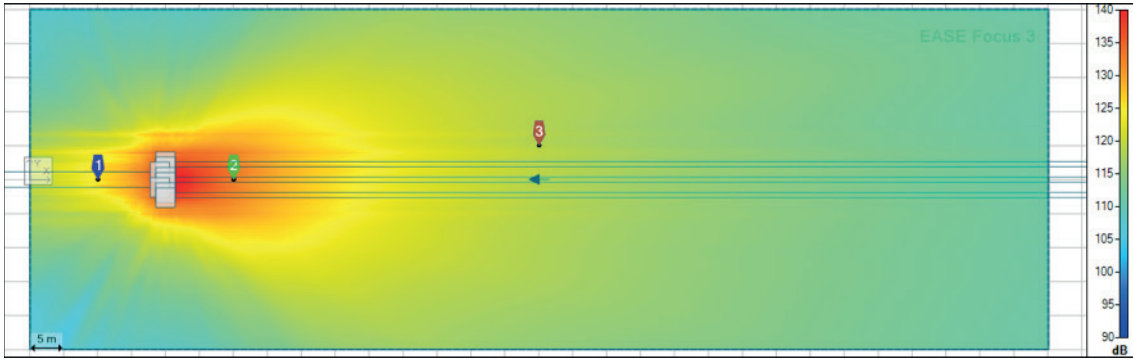

5. 12 subwoofer configurations

5.1. Array horizontal (Bi-direccional)

Remember to keep a maximum 1.7 meters of separation between subwoofers.

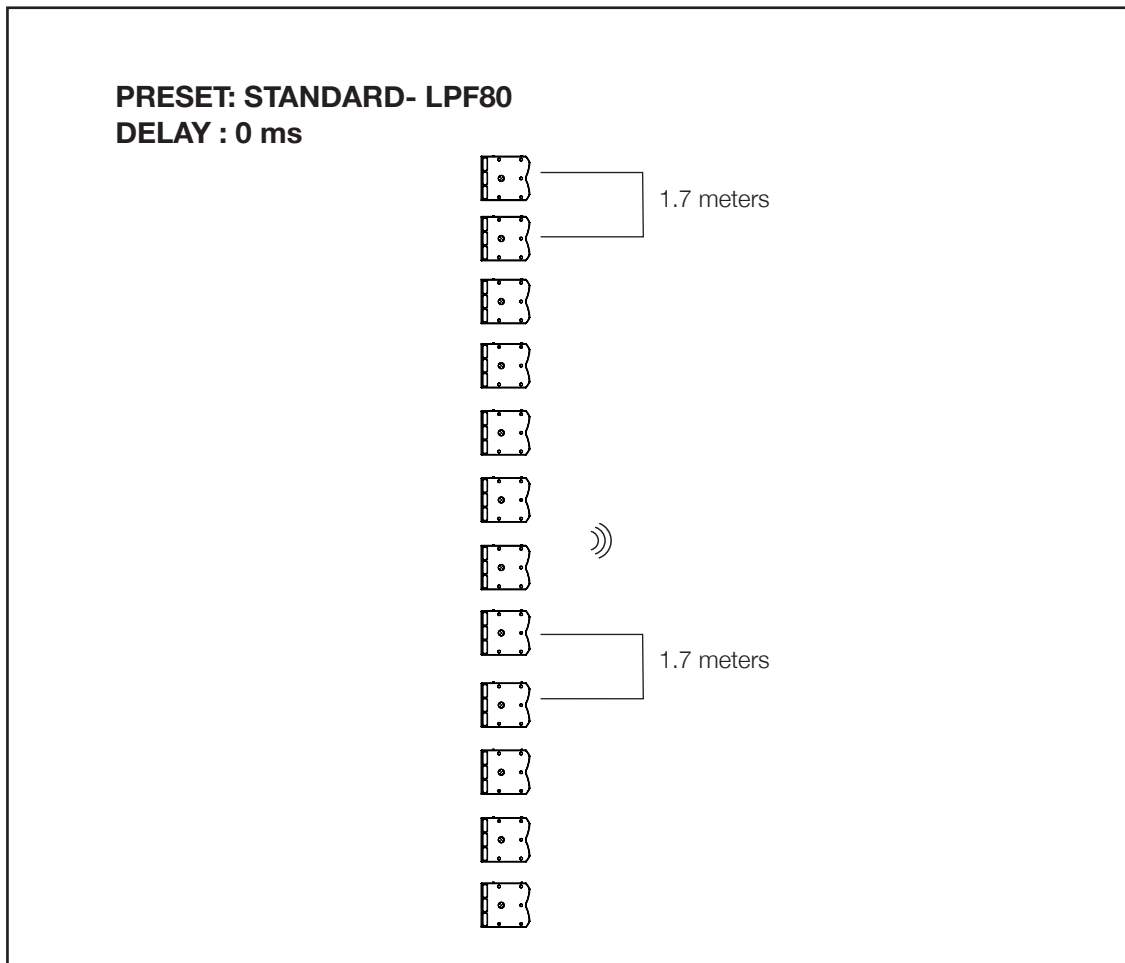

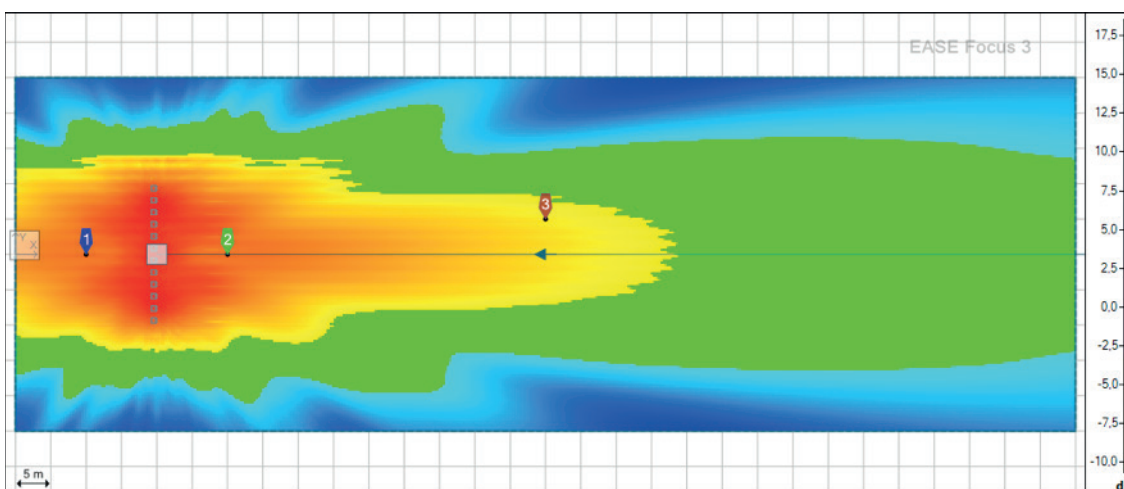
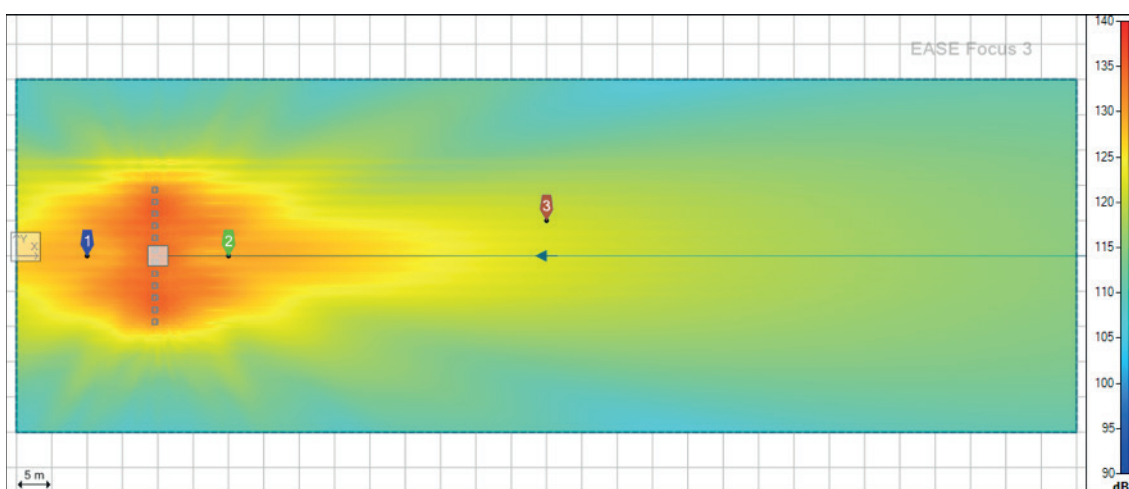
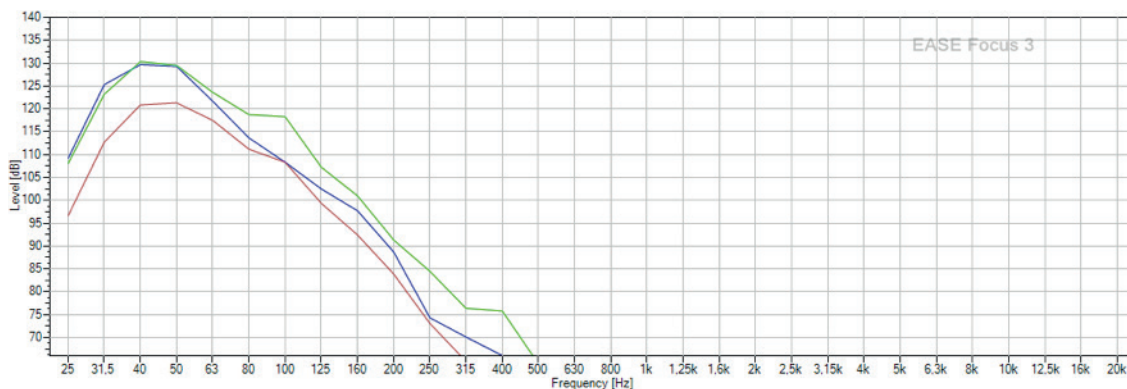

5.2. Horizontal array in arc (Bi-directional)

With a larger number of subwoofers we have selected 45 degrees of coverage angle; better for our audience area.

#	X [m]	Y [m]	Z [m]	Retardo	Retardo Total [ms]
1	0,00	-9,35	0,00	7,6	7,6
2	0,00	-7,65	0,00	4,1	4,1
3	0,00	-5,95	0,00	1,9	1,9
4	0,00	-4,25	0,00	0,7	0,7
5	0,00	-2,55	0,00	0,1	0,1
6	0,00	-0,85	0,00	0,0	0,0
7	0,00	0,85	0,00	0,0	0,0
8	0,00	2,55	0,00	0,1	0,1
9	0,00	4,25	0,00	0,7	0,7
10	0,00	5,95	0,00	1,9	1,9
11	0,00	7,65	0,00	4,1	4,1
12	0,00	9,35	0,00	7,6	7,6

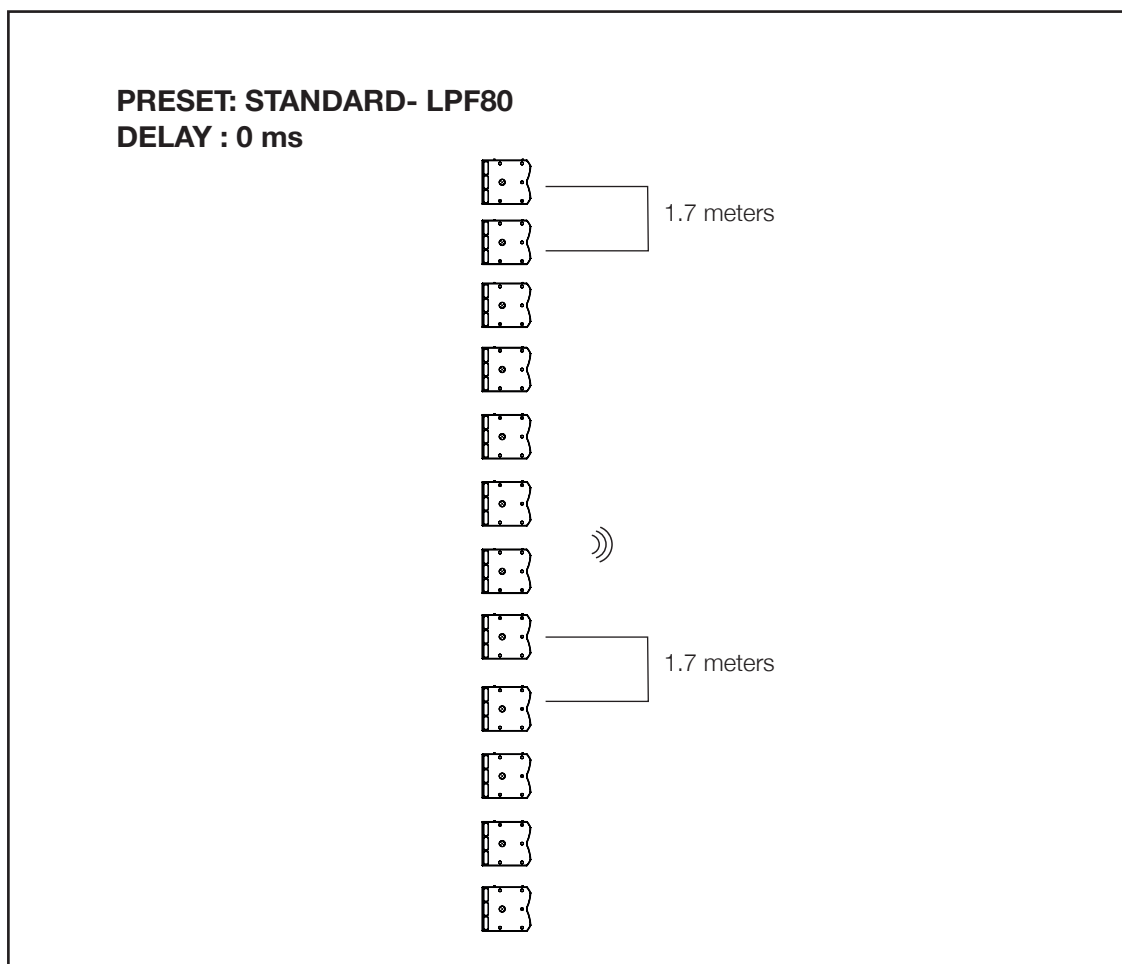

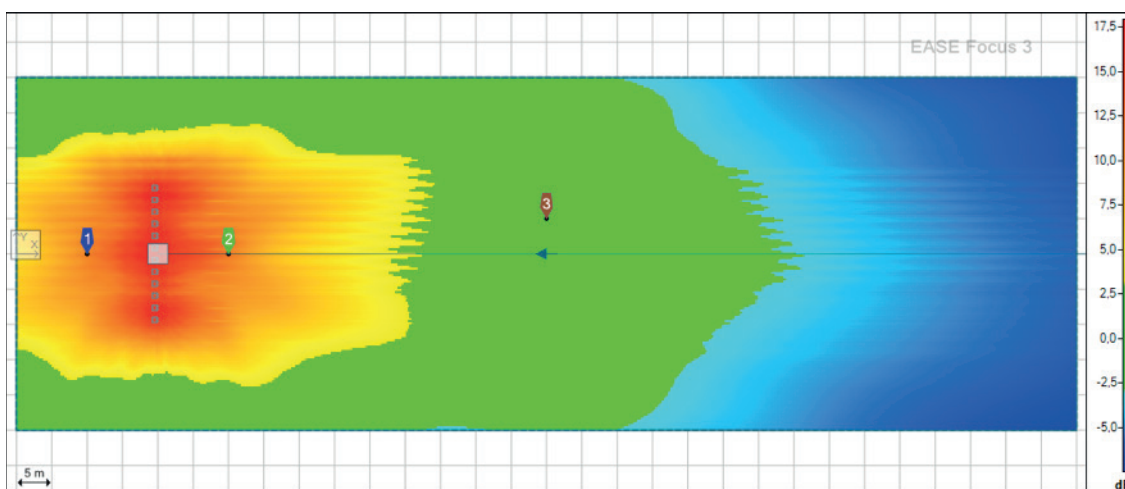
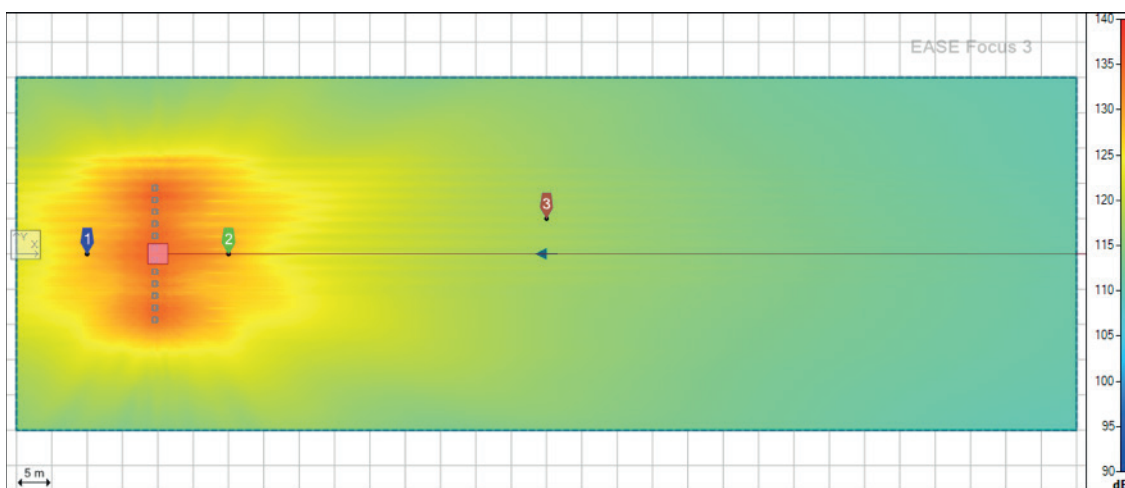
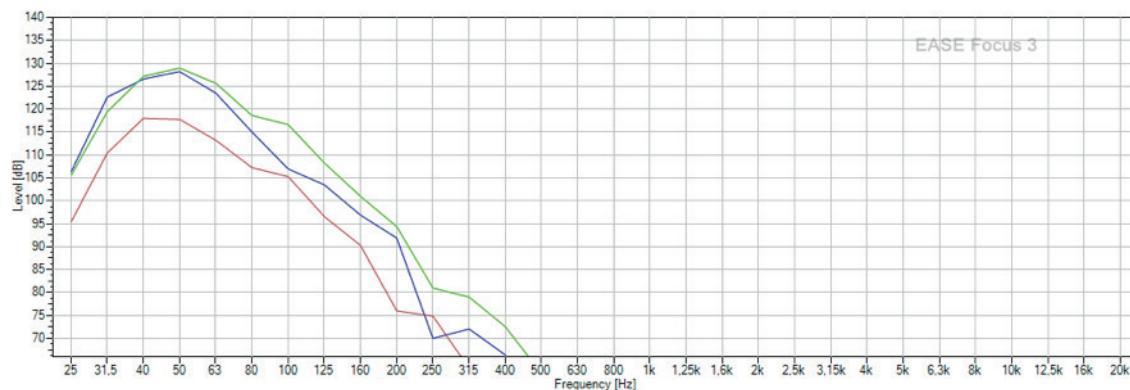

5.3. Horizontal array (Super cardioid)

This configuration is achieved by duplicating the same 6 subwoofer configuration as shown:

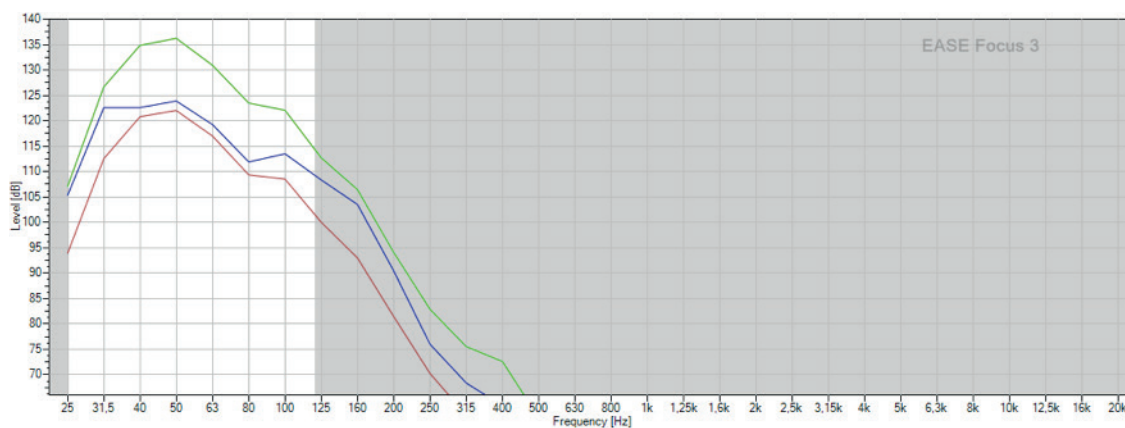
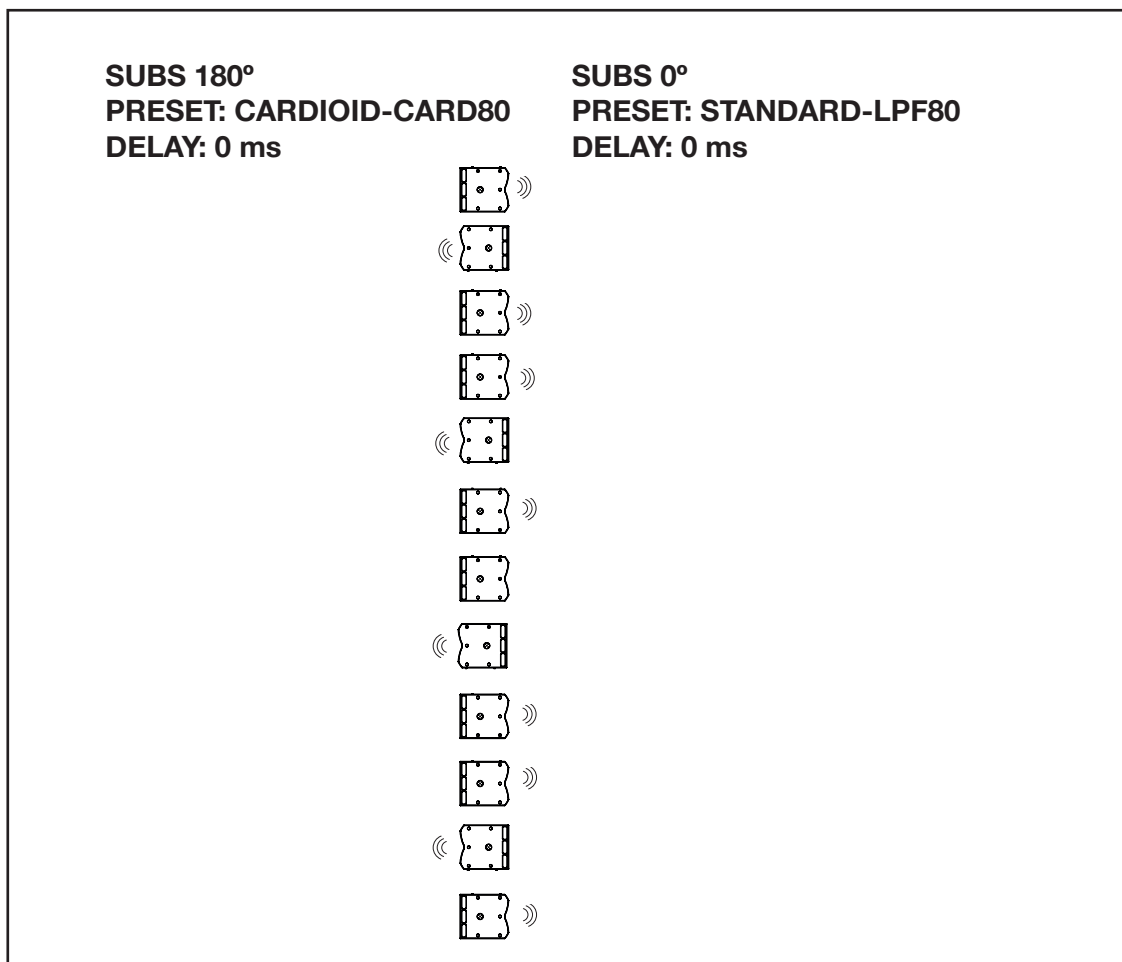

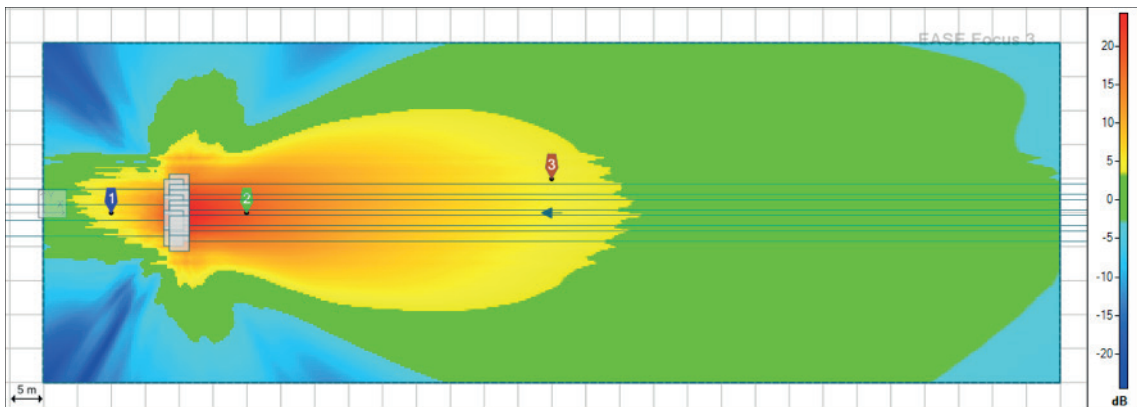
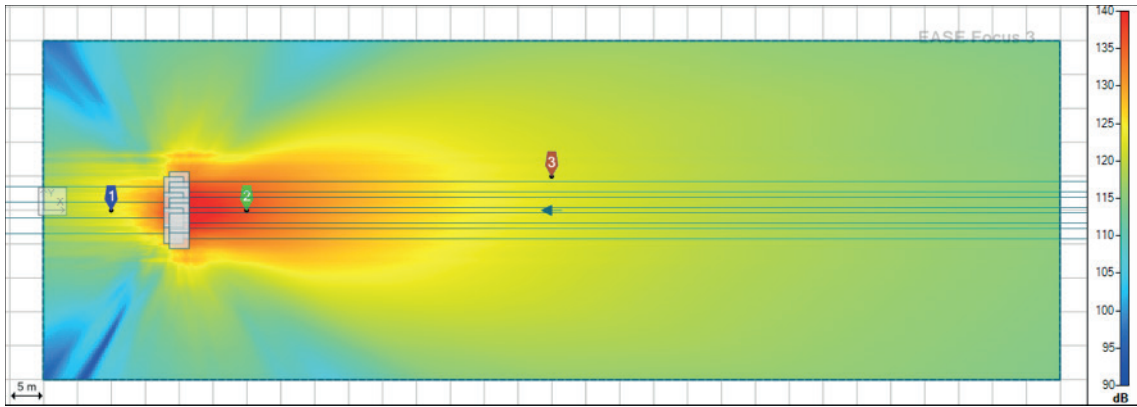

5.4. Spaced horizontal array (Hyper cardioid)

This configuration is the same as 5.3, but increasing the separation between each cluster of 3. A 4-meter distance is kept between the centre of the subwoofers looking back.

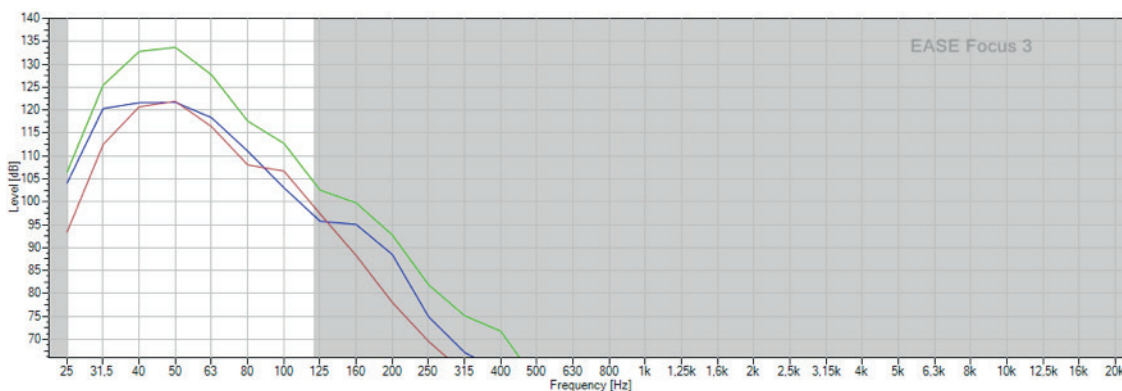
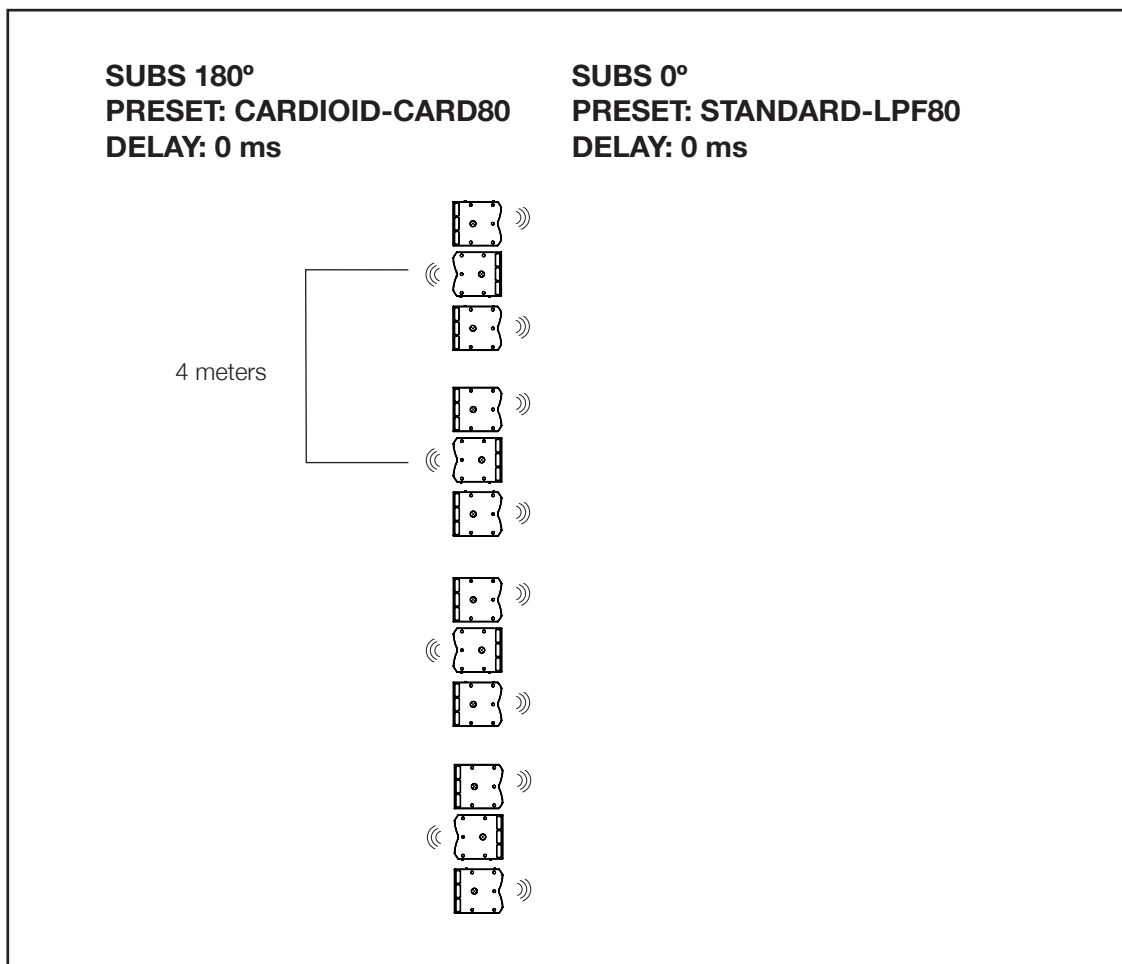

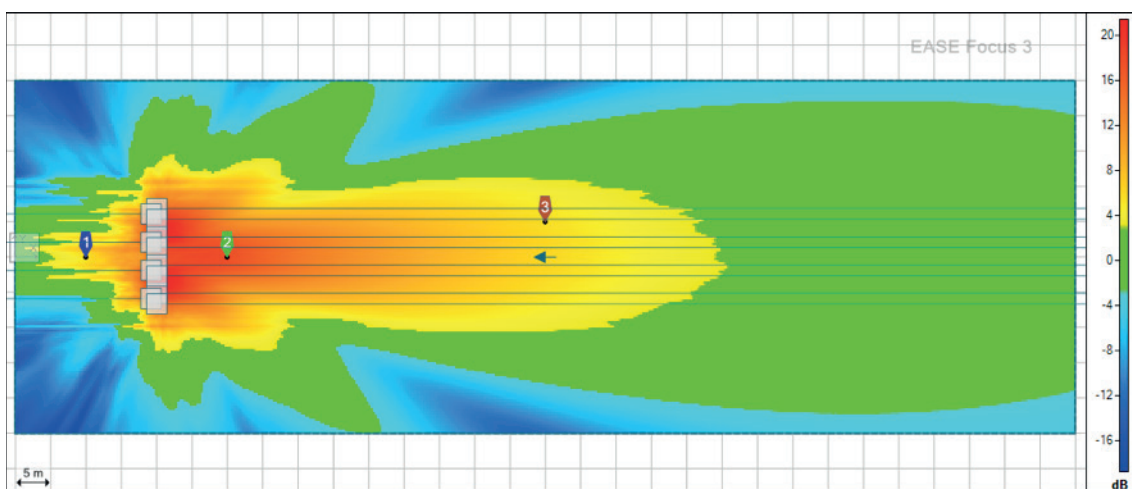
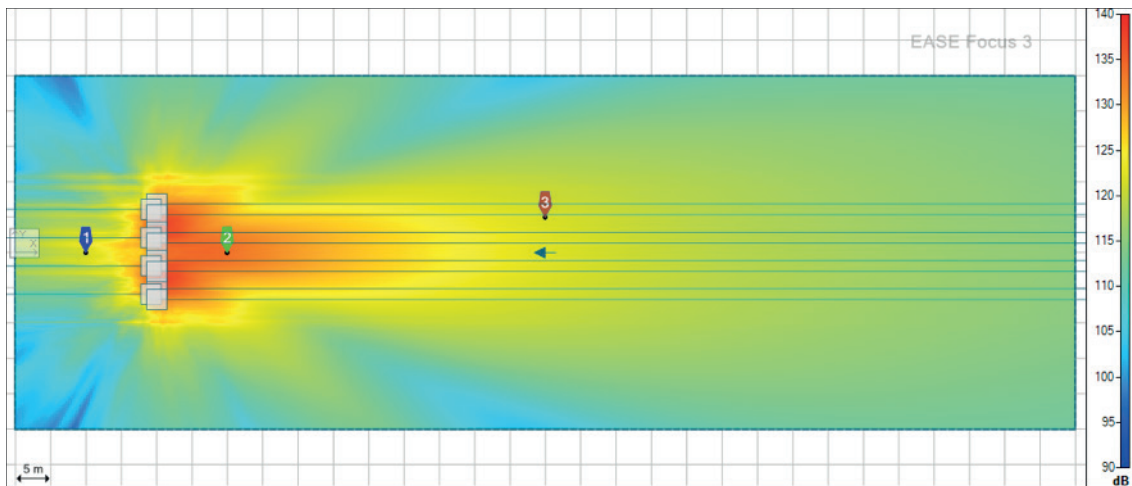

In this case a hyper cardioid pattern is created. So we can conclude that adding sets of our cardioid cluster narrows the directivity, greatly increasing the SPL in the audience area.

5.5. Stereo cardioid array

As made before for other configurations, we present the effect of using a “stereo” L-R configuration, now with 6 subwoofers per side:

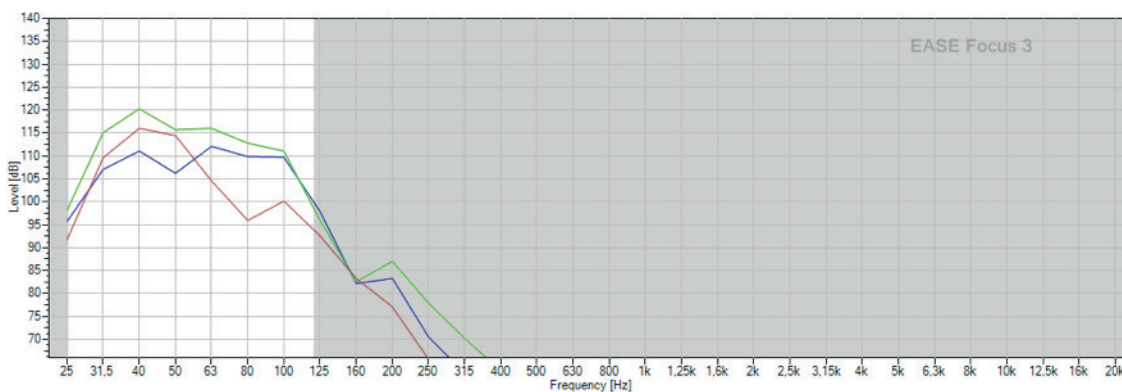
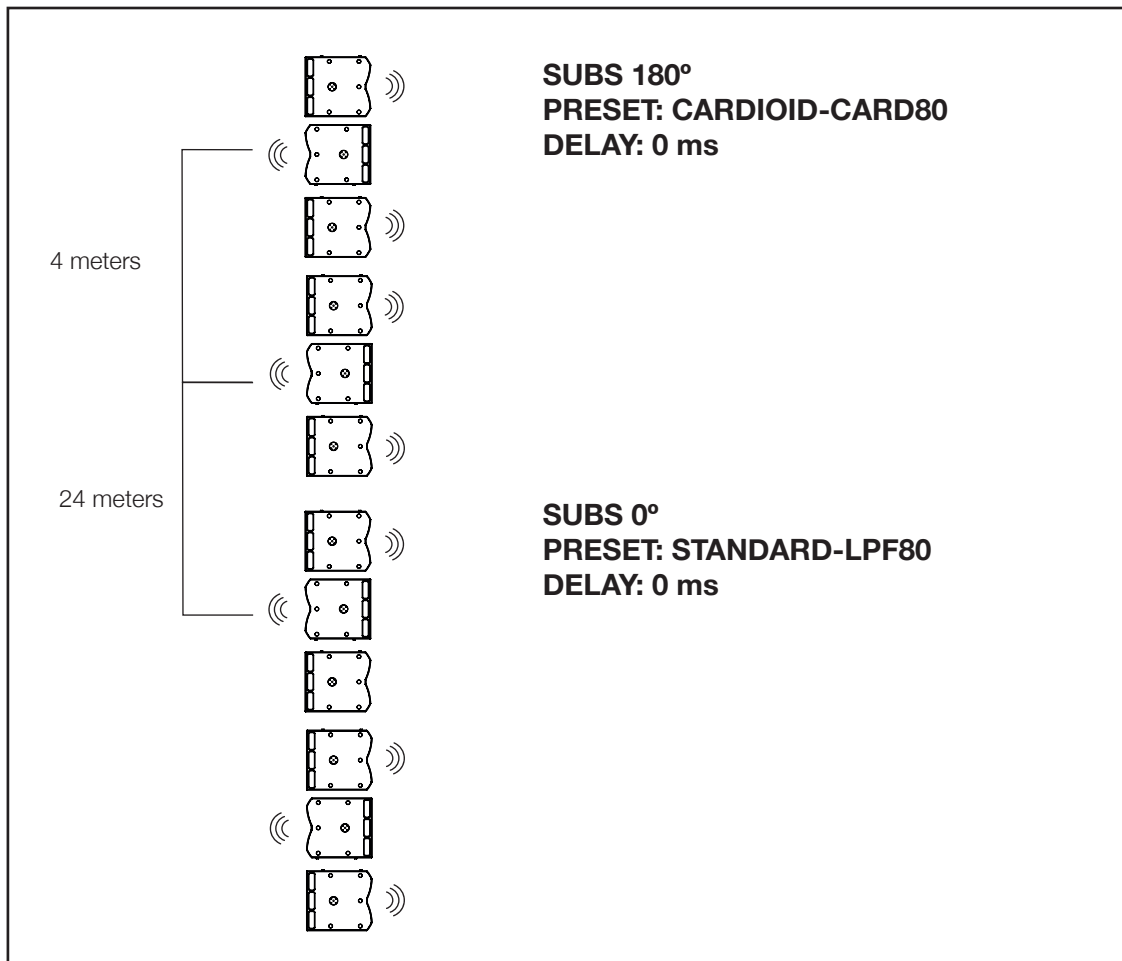

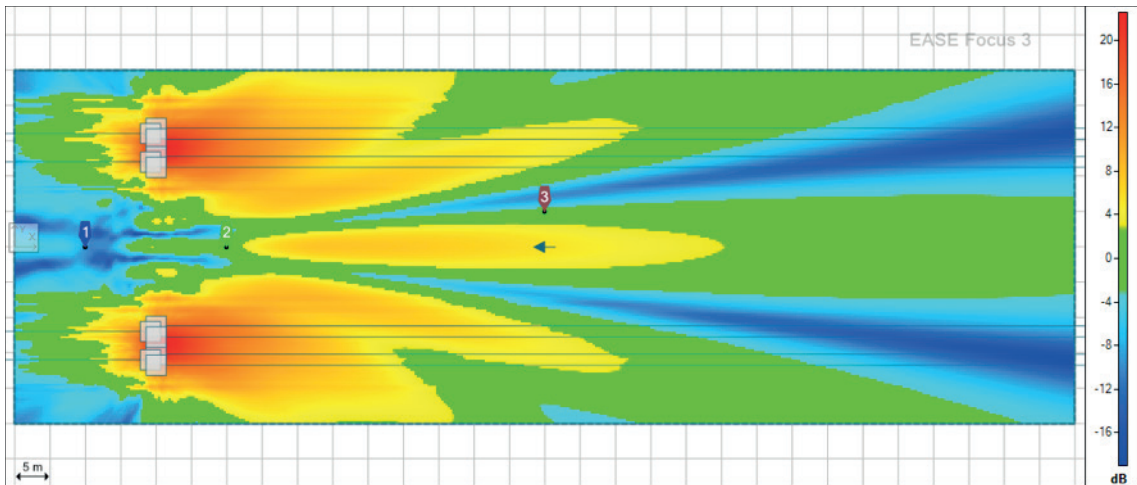
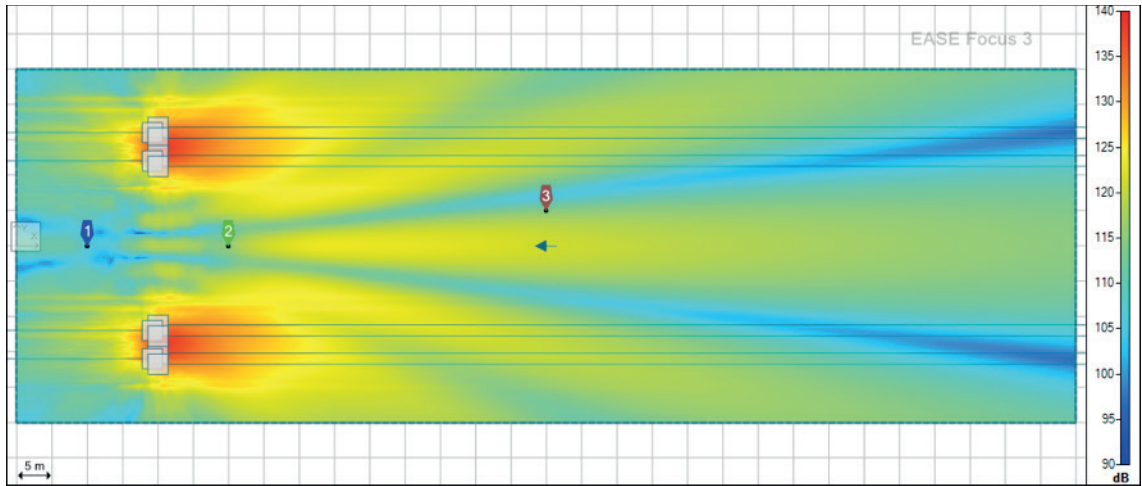

The cancellation alleys are still present, as happened with 6 and 8 subwoofers.

ANNEX – Acoustics fundamentals

• *Directividad*

The directivity of a speaker is a measure of how the speaker radiates sound at a certain frequency. For the subwoofers, without processing applied, the directivity corresponds to a polar pattern omnidirectional – i.e. the subwoofer radiates evenly around the cone. The polar pattern is a graphical representation of the directivity.

In this application guide we will see how to change the natural directivity of a subwoofer by placing several of them side-by-side to each other. We will configure cardioid arrays using only Amate Audio brand presets and bi-directional arrays with a minimum of signal processing. In the figure below we can check the different types of polar patterns.

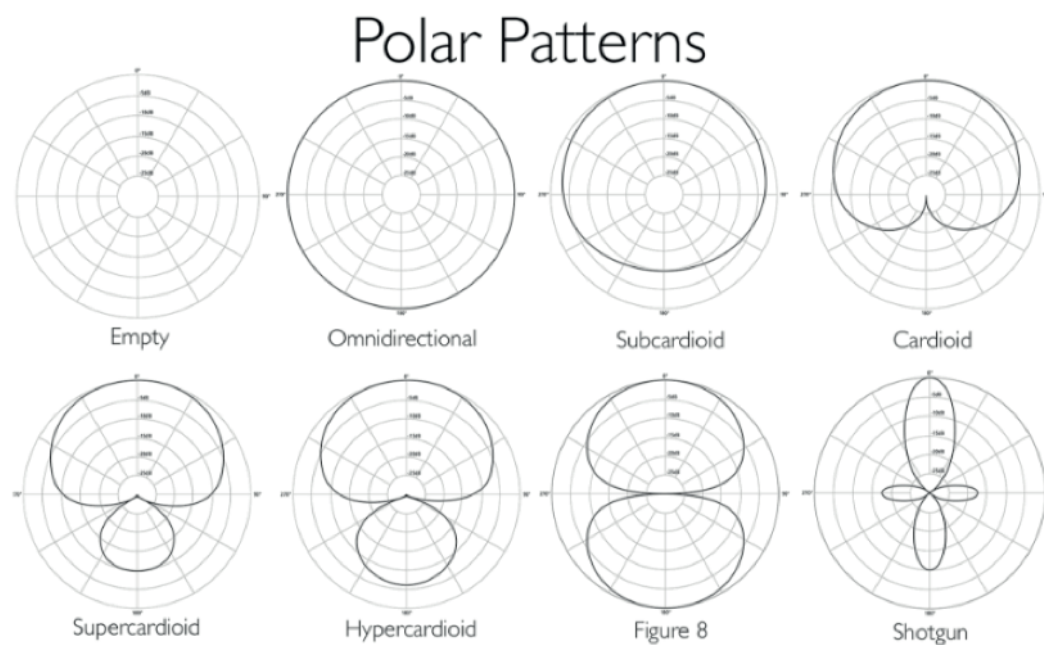

- **Acoustics basic concepts**

The sound pressure level (SPL) is measured in decibels and gives us a figure of how “loud” a sound is. It’s weighted with p_0 , the hearing threshold, established at 20 micro-Pascals.

$$dB_{SPL} = 20 \cdot \log \frac{p}{p_0} \quad p_0 = 20 \cdot 10^{-6} \text{ Pa}$$

The speed of sound is measured in meters per second. It’s independent of frequency. Strictly it depends on the humidity but in general is found using this formula:

$$\text{speed of sound} = 331.4 + 0.6 \cdot \text{Temperature}$$

The temperature is expressed in degrees Celsius. At 20°C the speed of sound is 343.4 m/s, that is usually floored down to 343 or 340 m/s.

The wavelength (λ) of certain frequency is the distance, in meters, between two points where the wave completes a cycle. In other words, from a point to the next point the wave starts to behave the same way. For example from a peak to the next peak.

$$\lambda = \frac{\text{speed of sound}}{\text{frequency}}$$

Below the graphical representation of the wavelength

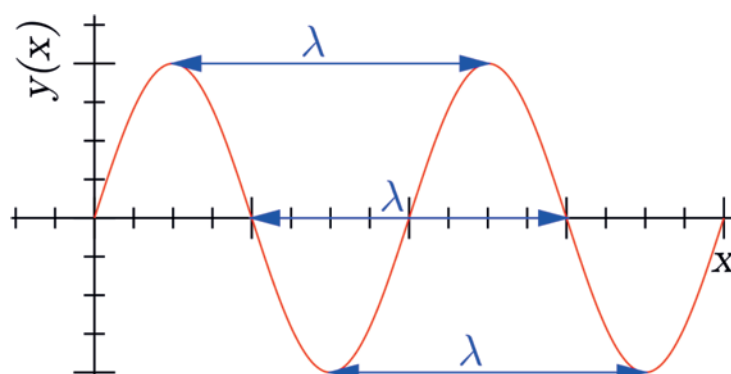

The phase (θ) of a signal is the relative time shift of this signal with another one used as reference.

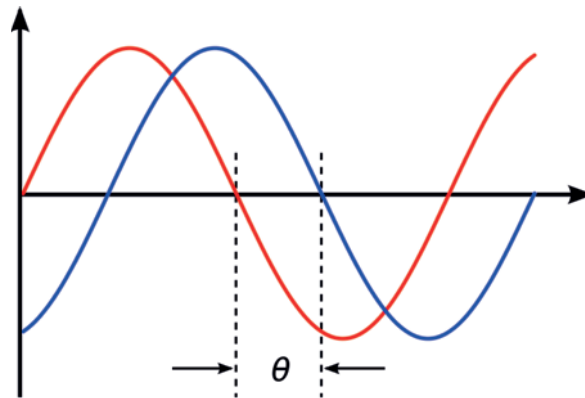

The phase is measured in radians or polar degrees. 180 polar degrees are the same as π radians. With the previous phase between two equal sinusoidal signals, this means the peak of one signal would be matching a valley of the phased version, so when summing both signals the result is no signal (destructive interference).

0 polar degrees is equal to 360 polar degrees (A complete cycle), the same as 0 and 2π radians. When summing signals with a phase of 0 polar degrees, the result is a double in the amplitude, the same as +6 dB in the signal (constructive interference).

- ***Other key acoustics concepts***

Finally, it is necessary to expand a little bit the previous information in order to understand better the complexity of the sub bass adjustment.

- When two signals of the same frequency are phase-shifted $180^\circ/\pi$ radians, the corresponding time of half of their frequency wavelength (Remember the formula we presented), they sum causing destructive interference. This is the phenomenon we use in our cardioid presets for enabling a simple configuration without effort. However, the destructive interference is also the responsible of the “alleys”, so we have to be careful when designing our own system.

- The acoustical waves are reflected by the surfaces whose width or height is greater than the wavelength of the reproduced frequencies. In acoustics engineering this phenomenon is known as reflection. In a nutshell when a wave is reflected in a surface, changes in the amplitude and phase happen, making very difficult to predict the SPL in a point of the room. Therefore it is very important to avoid the presence of walls, ceilings, stages or any other surfaces with a big area.

At Amate Audio we have done all what is in our hands to help you setting up subwoofer arrays with the less effort possible. If your application requires a room and you do not leave enough distance from the subwoofer array to walls or the stage, the sound performance will be affected.

We hope this document cleared doubts, even enough for letting you to create and try your own subwoofer arrays using our EASE Focus 3 library. In any case, you can always request an acoustical project to our application engineers. You only have to fill the form in the following link: <https://amateaudio.com/en/project-assessment/>



Amate Audio S.L.

Perpinyà, 25 · Polígon Industrial Nord · 08226 Terrassa
T. +34 93 735 65 65 – info@amateaudio.com

Factory: Violinista Vellsolà, 18 · 08222 Terrassa

Barcelona – SPAIN